

HP 510 Notebook PC

Maintenance and Service Guide

© Copyright 2006 Hewlett-Packard
Development Company, L.P.

Microsoft and Windows are U.S. registered trademarks of Microsoft Corporation. Intel, Pentium, and Celeron are trademarks or registered trademarks of Intel Corporation or its subsidiaries in the United States and other countries. Bluetooth is a trademark owned by its proprietor and used by Hewlett-Packard Company under license.

The information contained herein is subject to change without notice. The only warranties for HP products and services are set forth in the express warranty statements accompanying such products and services. Nothing herein should be construed as constituting an additional warranty. HP shall not be liable for technical or editorial errors or omissions contained herein.

This guide is a troubleshooting reference used for maintaining and servicing the computer. It provides comprehensive information on identifying computer features, components, and spare parts; on troubleshooting computer problems; and on performing computer disassembly procedures.

First Edition: December 2006

Document Part Number: 441658-001

Table of contents

1 Product description

2 External component identification

Top components	4
Pointing devices	4
Keys	5
Buttons and lights	6
Front components	7
Right-side components	8
Left-side components	9
Bottom components	10

3 Unknown user password

4 Illustrated parts catalog

Serial number location	12
Computer major components	13
Display assembly components	16
Plastics/Hardware Kit	17
Mass storage devices	18
Miscellaneous parts	19
Sequential part number listing	20

5 Removal and replacement procedures

Preliminary replacement requirements	23
Tools required	23
Service considerations	23
Plastic parts	23
Cables and connectors	23
Drive handling	24
Grounding guidelines	24
Electrostatic discharge damage	24
Packaging and transporting guidelines	26
Workstation guidelines	26
Equipment guidelines	27
Component replacement procedures	28
Serial number	28
Battery	29

Hard drive	30
Computer feet	32
Memory module	32
Mini PCI card module	34
Optical drive	36
Switch cover	38
Keyboard	40
Button board	43
Display assembly	44
Base enclosure	49
RTC battery	51
Fan assembly	52
Heat sink	53
Processor	55
Speaker	56
System board	58
PC Card assembly	61
TouchPad cable	63

6 Computer Setup

Computer Setup access	65
Computer Setup defaults	66
Computer Setup menus	67

7 Specifications

Computer specifications	70
15.4-inch, WXGA display specifications	71
Hard drive specifications	72
Primary 4-cell, Li-ion battery specifications	73
DVD±RW and CD-RW Super Multi Double-Layer Combo Drive specifications	74
DVD±RW/R and CD-RW Double-Layer Combo Drive specifications	75
System DMA specifications	76
System interrupt specifications	77
System I/O address specifications	78
System memory map specifications	80

8 Screw listing

Phillips PM2.5×6.0 captive screw	82
Phillips PM3.0×3.0 screw	83
Phillips PM2.0×9.0 screw	84
Phillips PM2.0×3.0 screw	87
Phillips PM2.0×2.0 screw	90
Phillips PM2.0×7.0 screw	91
Phillips PM2.5×6.0 screw	92
Phillips PM2.5×4.0 screw	94

9 Backup and recovery



Backup	95
Safeguarding your data	95

Backing up the system	95
Backing up specific files or folders	95
Backing up the entire hard drive	96
Backing up modifications made to the system	97
Scheduling backups	97
Recovery	97
Creating recovery discs (highly recommended)	98
Performing a recovery	99
Performing a recovery from the recovery discs	99
Performing a recovery from the hard drive	99
Initiating a recovery in Windows	99
Initiating a recovery from the hard drive recovery partition	99
10 Connector pin assignments	
Audio-out (headphone)	100
Audio-in (microphone)	100
External monitor	101
RJ-11 (modem)	102
RJ-45 (network)	102
Universal Serial Bus	103
11 Power cord set requirements	
Requirements for all countries or regions	104
Requirements for specific countries or regions	105
12 Recycling	
Battery	106
Display	107
Index	113

1 Product description

Category	Description	System board	System board	System board
		910GML without wireless local area network (WLAN)	910GML with WLAN	915GM with WLAN
Product Name	HP 510 Notebook PC	√	√	√
Processors	Intel® Pentium® M 770 (2.13-GHz) Processor 533-MHz front side bus (FSB), 1-MB L2 cache, socketed			√
	Intel Celeron® M 360 (1.40-GHz) Processor 400-MHz FSB, 512-KB L2 cache, socketed	√	√	
Chipset	Intel 915GM			√
	Intel 910GML	√	√	
	Southbridge: Intel ICH-6M	√	√	√
Graphics	UMA	√	√	√
Panels	15.4-inch, WXGA (16:10 aspect ratio) BrightView with wireless antenna transceivers and cables		√	√
	15.4-inch, WXGA (16:10 aspect ratio) BrightView without wireless antenna transceivers and cables	√		
Memory	<ul style="list-style-type: none"> One SODIMM slot Customer accessible/upgradable DDRII PC2-4200 (533 MHz) 	√	√	√
	256-MB total system memory (256-MB × 1)	√	√	
	512-MB total system memory (512-MB × 1)	√	√	√
	1024-MB total system memory (1024-MB × 1)	√	√	√
Hard drives	<ul style="list-style-type: none"> Supports all 9.5-mm, 2.5-inch hard drives Parallel ATA 	√	√	√
	60-GB, 5400-rpm			√
	40-GB, 4200-rpm	√	√	√

Category	Description	System board	System board	System board	
		910GML without wireless local area network (WLAN)	910GML with WLAN	915GM with WLAN	
Optical drives (fixed)	<ul style="list-style-type: none"> 12.7-mm tray load Parallel ATA Fixed, no modular requirements (1 screw removal) 	√	√	√	
	DVD±RW and CD-RW Super Multi Double-Layer Combo Drive		√	√	
	DVD±RW/R and CD-RW Double-Layer Combo Drive	√	√		
Diskette drive	Supports external USB drive only	√	√	√	
Audio	<ul style="list-style-type: none"> Conexant CX20468 Single speaker Headphone and microphone jacks 	√	√	√	
	Modem	<ul style="list-style-type: none"> Conexant CX20493 (Ultima HD2.0) Modem cable included 	√	√	√
	Ethernet	<ul style="list-style-type: none"> Intel 82562V Ethernet cabel included S4/S5 wake on LAN 	√	√	√
Wireless	Integrated wireless options by way of Mini PCI card:				
	Option for no wireless				
	WLAN antennae (2, configured in display assembly)		√	√	
	Intel 2200 802.11b/g		√	√	
External media card	One Type I/II PC Card slot, 16-bit PCMCIA and 32-bit CardBus	√	√	√	
Ports	<ul style="list-style-type: none"> VGA (Dsub 15-pin) USB 2.0 ports (2) Audio-out (mono microphone) Audio-in (stereo headphone) 2-pin AC jack RJ-11 modem RJ-45 Ethernet (includes link and activity LEDs) 	√	√	√	
	Docking	Docking support			
	Keyboard/ pointing devices	<ul style="list-style-type: none"> Keyboard with embedded numeric keypad TouchPad with 2 buttons and one-way scroll 	√	√	√

Category	Description	System board	System board	System board
		910GML without wireless local area network (WLAN)	910GML with WLAN	915GM with WLAN
Power requirements	4-cell, 2.2-Ahr Li-ion battery (32 Whr)	√	√	√
	 NOTE The HP 510 Notebook PC does not support Smart Battery technology.			
	65-W AC adapter with localized cable plug support (2-wire plug with ground pin, supports 2-pin DC connector)	√	√	√
	 NOTE The HP 510 Notebook PC does not support Smart AC adapter technology.			
Security	Security cable slot	√	√	√
Operating system	Preinstalled:	√	√	√
	<ul style="list-style-type: none"> • Microsoft® Windows® XP Home (SP2) • Microsoft Windows XP Pro (in the United States only) • FreeDOS 			
Serviceability	End-user replaceable parts:			
	Hard drive	√	√	√
	Memory module	√	√	√
	Mini PCI card module		√	√
	Battery (system)	√	√	√
	AC adapter	√	√	√

2 External component identification

Top components

Pointing devices

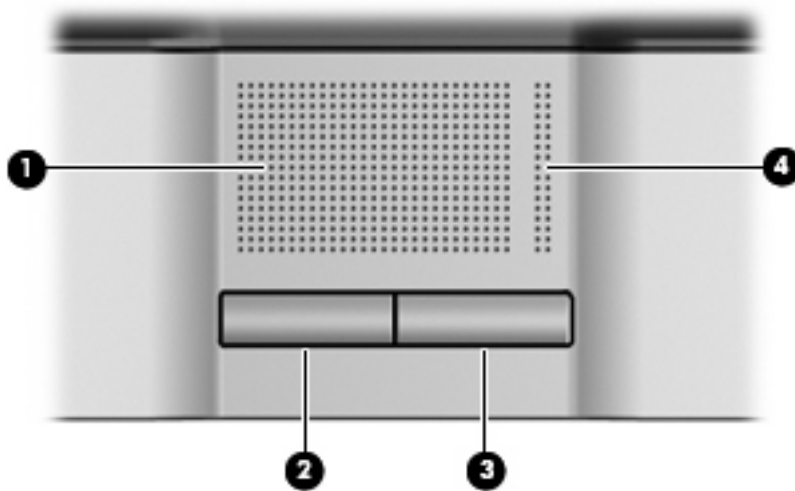

Item	Component	Function
(1)	TouchPad	Moves the pointer and selects or activates items on the screen.
(2)	Left TouchPad button	Functions like the left button on an external mouse.
(3)	Right TouchPad button	Functions like the right button on an external mouse.
(4)	TouchPad scroll zone	Scrolls up or down.

Keys

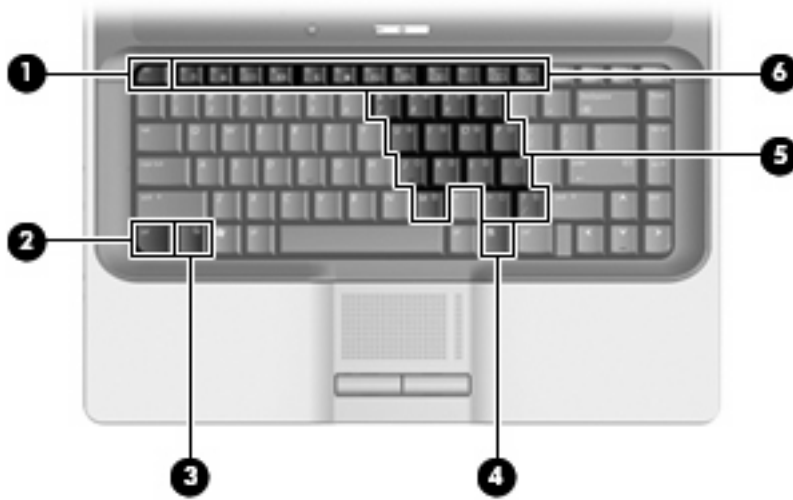

Item	Component	Function
(1)	esc key	Displays system information when pressed in combination with the fn key.
(2)	fn key	Executes frequently used system functions when pressed in combination with a function key or the esc key.
(3)	Windows logo key	Displays the Windows Start menu.
(4)	Windows applications key	Displays a shortcut menu for items beneath the pointer.
(5)	Embedded numeric keypad keys	Can be used like the keys on an external numeric keypad.
(6)	Function keys	Execute frequently used system functions when pressed in combination with the fn key.

Buttons and lights

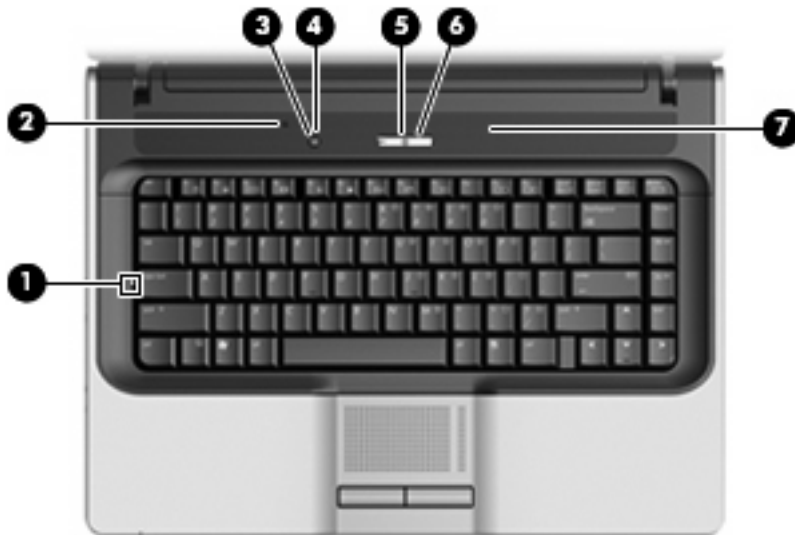

Item	Component	Function
(1)	Caps lock light	On: Caps lock is on.
(2)	Internal display switch	Turns off the display if the display is closed while the power is on.
(3)	Wireless button (select models only)	Turns the wireless feature on or off, but does not create a wireless connection.
		 NOTE A wireless network must be set up in order to establish a wireless connection.
(4)	Wireless light (select models only)	<ul style="list-style-type: none"> Blue: An integrated wireless device, such as a wireless local area network (WLAN) device and/or a Bluetooth® device, is turned on. Off: All wireless devices are turned off.
(5)	Power button	<ul style="list-style-type: none"> When the computer is off, press the button to turn on the computer. When the computer is on, press the button to enter hibernation. When the computer is in standby, press the button briefly to exit standby. When the computer is in hibernation, press the button briefly to exit hibernation. <p>If the computer has stopped responding and Windows shutdown procedures cannot be used, press and hold the power button for at least 5 seconds to turn off the computer.</p>
(6)	Power light	<ul style="list-style-type: none"> On: The computer is on. Blinking: The computer is in standby. Off: The computer is off or in hibernation.
(7)	Speaker	Produces sound.

Front components



Item	Component	Function
(1)	Wireless antennae (select models only)	Send and receive signals from one or more wireless devices.
(2)	Battery light	<ul style="list-style-type: none">• On: A battery is charging.• Blinking: A battery that is the only available power source has reached a low-battery condition. When the battery reaches a critical low-battery condition, the battery light begins to blink rapidly.• Off: If the computer is plugged into an external power source, the light turns off when all batteries in the computer are fully charged. If the computer is not plugged into an external power source, the light stays off until the battery reaches a low-battery condition.
(3)	Audio-out (headphone) jack	Produces sound when connected to optional stereo speakers, headphones, ear buds, or a headset.
(4)	Audio-in (microphone) jack	Connects an optional computer headset microphone, stereo array microphone, or monaural microphone.

Right-side components





Item	Component	Function
(1)	Optical drive	Reads an optical disc.
(2)	Security cable slot	Attaches an optional security cable to the computer.

 **NOTE** The security cable is designed to act as a deterrent, but it may not prevent the computer from being mishandled or stolen.

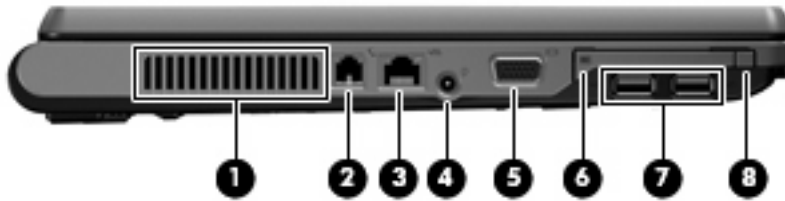

Left-side components

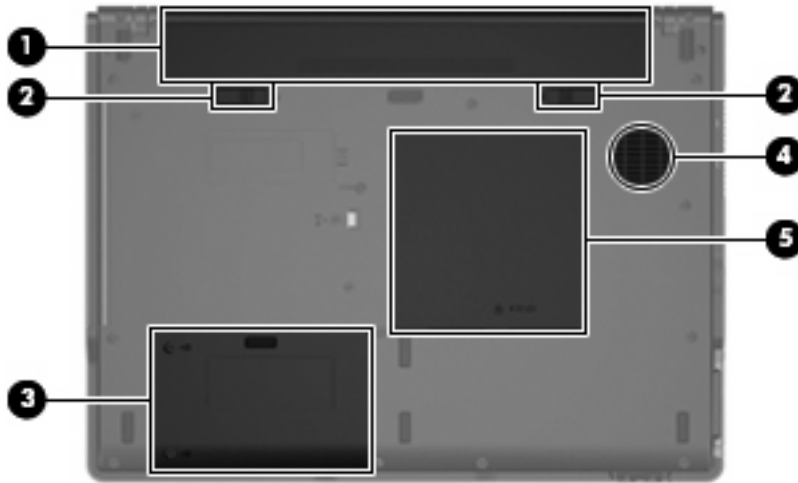

Item	Component	Function
(1)	Vent	<p>Enables airflow to cool internal components.</p> <p> CAUTION To prevent overheating, do not obstruct vents. Use the computer only on a hard, flat surface. Do not allow another hard surface, such as an adjoining optional printer, or a soft surface, such as pillows or thick rugs or clothing, to block airflow.</p> <p> NOTE The computer fan starts up automatically to cool internal components and prevent overheating. It is normal for the internal fan to cycle on and off during routine operation.</p>
(2)	RJ-11 (modem) jack (select models only)	Connects a modem cable.
(3)	RJ-45 (network) jack	Connects a network cable.
(4)	Power connector	<p>Connects an AC adapter.</p> <p> NOTE The HP 510 Notebook PC does not support Smart AC adapter technology.</p>
(5)	External monitor port	Connects an optional VGA external monitor or projector.
(6)	PC Card slot	Supports optional Type I or Type II 32-bit (CardBus) or 16-bit PC Cards.
(7)	USB ports (2)	Connect an optional USB device.
(8)	PC Card eject button	Ejects the PC Card from the PC Card slot.

Bottom components



Item	Component	Function
(1)	Battery bay	<p>Holds the battery.</p> <p> NOTE The HP 510 Notebook PC does not support Smart Battery technology.</p>
(2)	Battery release latches (2)	Release the battery from the battery bay.
(3)	Hard drive bay	Holds the hard drive.
(4)	Vent	<p>Enables airflow to cool internal components.</p> <p> CAUTION To prevent overheating, do not obstruct vents. Use the computer only on a hard, flat surface. Do not allow another hard surface, such as an adjoining optional printer, or a soft surface, such as pillows or thick rugs or clothing, to block airflow.</p> <p> NOTE The computer fan starts up automatically to cool internal components and prevent overheating. It is normal for the internal fan to cycle on and off during routine operation.</p>
(5)	Memory module compartment	Contains the memory module slot.

3 Unknown user password

If the computer you are servicing has an unknown user password, follow these steps to clear the password.



NOTE These steps also clear CMOS.

Before disassembling the computer, follow these steps:

1. Shut down the computer. If you are unsure whether the computer is off or in hibernation, turn the computer on, and then shut it down through the operating system.
2. Disconnect all external devices connected to the computer.
3. Disconnect the power cord.
4. Remove the battery (see [Battery on page 29](#)).
5. Remove the real-time clock (RTC) battery (see [RTC battery on page 51](#)).
6. Wait approximately 5 minutes.
7. Replace the RTC battery and reassemble the computer.
8. Connect AC power to the computer. Do not reinsert any batteries at this time.
9. Turn on the computer.

All passwords and all CMOS settings have been cleared.

4 Illustrated parts catalog

Serial number location

When ordering parts or requesting information, provide the computer serial number and model number located on the bottom of the computer.



Computer major components

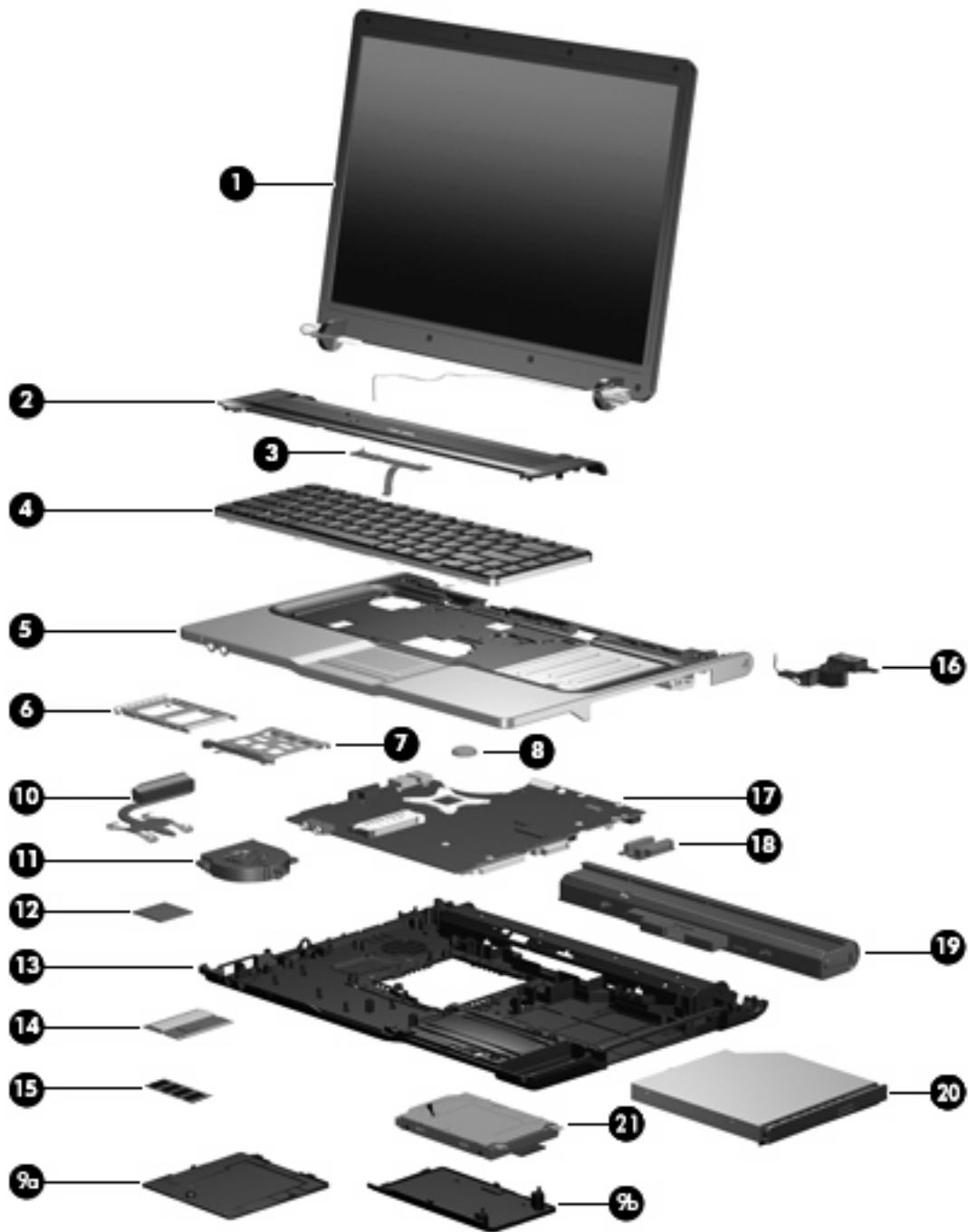

Item	Description	Spare part number
(1)	Display assemblies	
	15.4-inch, WXGA BrightView display assembly for use only with computer models with wireless LAN capability (includes wireless antenna transceivers and cables)	440716-001
	15.4-inch, WXGA BrightView display assembly for use only with computer models without wireless LAN capability	440715-001

Item	Description	Spare part number
(2)	Switch covers	
	For use only with computer models with wireless LAN capability (includes wireless button and wireless light)	441623-001
	For use only with computer models without wireless LAN capability	441624-001
(3)	Button board	441632-001
(4)	Keyboards	
	Belgium	438231-A41
	Brazil	438531-201
	The Czech Republic	438531-221
	Denmark	438231-081
	Europe	438531-021
	France	438531-051
	Germany	438231-041
	Greece	438231-151
	Hungary	438231-211
	Israel	438531-BB1
	Italy	438231-061
	Latin America	438231-161
	Norway	438231-091
	Poland	438231-241
	Portugal	438231-131
	Russia	438231-251
	Saudi Arabia	438231-171
	Slovakia	438231-231
	Slovenia	438231-BA1
	South Africa	438231-AR1
	Spain	438231-071
	Sweden and Finland	438231-B71
	Thailand	438231-281
	Turkey	438231-141
	The United Kingdom	438231-031
	The United States	438231-001
(5)	Top cover (includes TouchPad and TouchPad cable)	441626-001
	TouchPad cable (not illustrated)	441638-001

Item	Description	Spare part number
(6)	PC Card slot bezel	438527-001
(7)	PC Card assembly	438551-001
(8)	RTC battery	438556-001
	Plastics/Hardware Kit	441630-001
(9a)	Memory/Mini PCI card module cover (includes 1 captive screw, secured by a C-clip)	
(9b)	Hard drive cover (includes 2 captive screws, secured by C-clips)	
(10)	Heat sink (includes thermal paste)	438529-001
(11)	Fan assembly	438528-001
(12)	Processors (include thermal paste)	
	Intel Pentium M 770 2.13-GHz processor	440717-001
	Intel Celeron M 360 1.40-GHz processor	438554-001
(13)	Base enclosure (includes 6 rubber feet, not illustrated)	441625-001
	Rubber Feet Kit (includes 6 rubber feet, not illustrated)	438557-001
(14)	802.11b/g Mini PCI card WLAN module for use in the countries or regions listed below. These countries or regions are categorized as most of the world (MOW):	390501-001
	Argentina, Brazil, Canada, Chile, Mexico, Taiwan, the United States	
	802.11b/g Mini PCI card WLAN module for use in the countries or regions listed below. These countries or regions are categorized as the rest of the world (ROW):	390501-002
	Australia, Austria, Belarus, Belgium, Brunei, Bulgaria, Croatia, Cyprus, the Czech Republic, Denmark, Estonia, Finland, France, Germany, Greece, Hong Kong, Hungary, Iceland, India, Indonesia, Ireland, Israel, Italy, Japan, Jordan, Kuwait, Latvia, Lithuania, Luxembourg, Malaysia, the Netherlands, New Zealand, Norway, Pakistan, the People's Republic of China, the Philippines, Poland, Portugal, Romania, Russia, Saudi Arabia, Singapore, Slovakia, Slovenia, South Africa, South Korea, Spain, Sri Lanka, Sweden, Switzerland, Thailand, Turkey, the United Arab Emirates, the United Kingdom, Ukraine	
(15)	Memory modules, 1-DIMM	
	PC2-4200, 512-MB	438546-001
	PC2-4200, 256-MB	438545-001
(16)	Speaker	441627-001
(17)	System boards	
	For use only with full-featured computer models	441635-001
	For use only with defeatured computer models with wireless LAN capability	441636-001
	For use only with defeatured computer models without wireless LAN capability	441637-001
(18)	Optical drive connector board	441631-001
(19)	4-cell, 2.2-Ahr battery	440704-001
(20)	Optical drives (include bezel and optical drive bracket)	
	DVD±RW and CD-RW Super Multi Double-Layer Combo Drive	438523-001
	DVD±RW/R and CD-RW Double-Layer Combo Drive	438524-001

Item	Description	Spare part number
(21)	Hard drives (include hard drive bracket and connector)	
	5400-rpm, 60-GB	438526-001
	4200-rpm, 40-GB	438525-001

Display assembly components

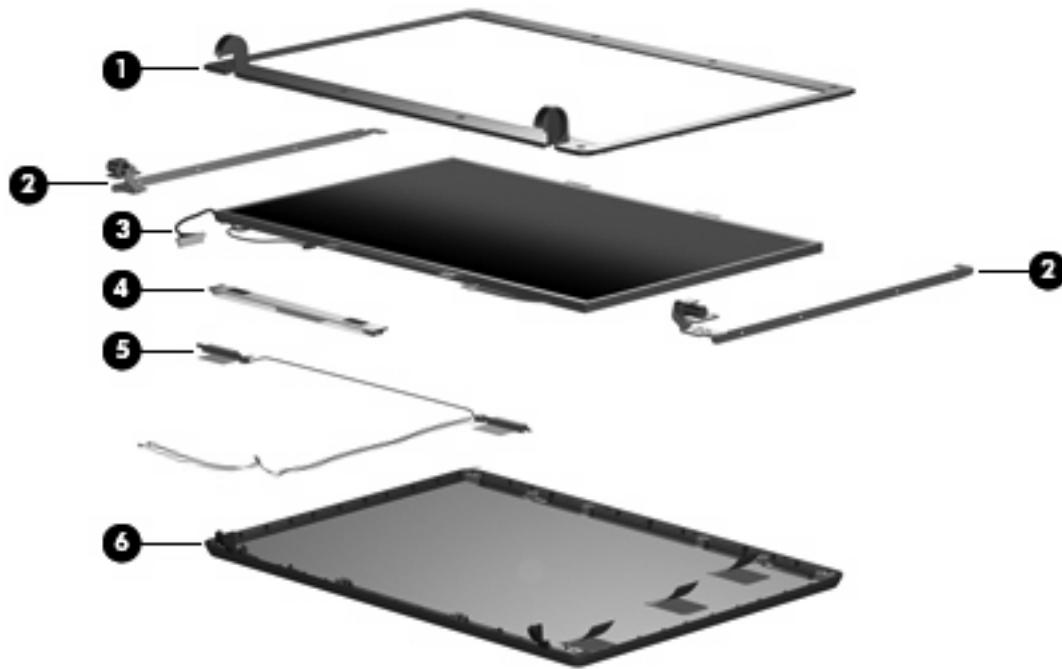

Item	Description	Spare part number
(1)	Display bezel	440706-001
(2)	Display Hinge Kit	400707-001
(3)	15.4-inch, WXGA, BrightView display panel	440711-001
(4)	Display inverter	441628-001
(5)	Wireless Antenna Kit (includes wireless antenna transceivers and cables)	441639-001
(6)	Display enclosures	
	For use only with computer models with wireless LAN capability (includes logo and wireless antenna transceivers and cables)	440710-001
	For use only with computer models without wireless LAN capability (includes logo)	440709-001
	Display Cable Kit (not illustrated)	440708-001
	Display Label Kit (not illustrated)	440705-001
	Display Screw Kit (not illustrated)	440714-001
	Display Screw Cover Kit (not illustrated)	438542-001

Plastics/Hardware Kit

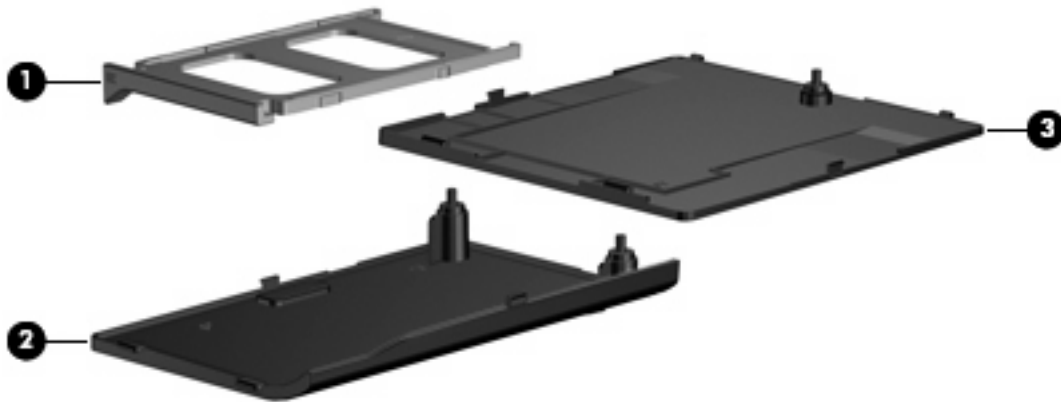

Item	Description	Spare part number
	Plastics/Hardware Kit	441630-001
(1)	PC Card slot bezel	
(2)	Hard drive cover (includes 2 captive screws, secured by C-clips)	
(3)	Memory/Mini PCI card module cover (includes 1 captive screw, secured by a C-clip)	

Mass storage devices



Item	Description	Spare part number
(1)	Hard drives (include frame and connector)	
	5400-rpm, 60-GB	438526-001
	4200-rpm, 40-GB	438525-001
(2)	Optical drives (include bezel and bracket)	
	DVD±RW/R and CD-RW Double-Layer Combo Drive	438524-001
	DVD±RW and CD-RW Super Multi Double-Layer Combo Drive	438523-001

Miscellaneous parts

Description	Spare part number
65-watt AC adapter	418872-001
Power cords:	
Australia	350055-011
Brazil	350055-201
Denmark	350055-081
Europe	350055-021
French Canada	350055-DB1
Israel	350055-BB1
Italy	350055-061
Japan	350055-291
Korea	350055-AD1
People's Republic of China	350055-AA1
Switzerland	350055-BG1
The United Kingdom	350055-031
The United States	350055-001
Screw Kit	441629-001
Phillips PM3.0×3.0 screw	
Phillips PM2.5×6.0 captive screw	
Phillips PM2.5×6.0 screw	
Phillips PM2.5×4.0 screw	
Phillips PM2.0×9.0 screw	
Phillips PM2.0×7.0 screw	
Phillips PM2.0×3.0 screw	
Phillips PM2.0×2.0 screw	

Sequential part number listing

Spare part number	Description
350055-001	Power cord use in the United States
350055-011	Power cord for use in Australia
350055-021	Power cord for use in Europe
350055-031	Power cord for use in the United Kingdom
350055-061	Power cord for use in Italy
350055-081	Power cord for use in Denmark
350055-201	Power cord for use in Brazil
350055-291	Power cord for use in Japan
350055-AA1	Power cord for use in the People's Republic of China
350055-AD1	Power cord for use in Korea
350055-BB1	Power cord for use in Israel
350055-BG1	Power cord for use in Switzerland
350055-DB1	Power cord for use in French Canada
390501-001	802.11b/g Mini PCI card WLAN module for use in the MOW countries or regions listed below: Argentina, Brazil, Canada, Chile, Mexico, Taiwan, the United States
390501-002	802.11b/g Mini PCI card WLAN module for use in the ROW countries or regions listed below: Australia, Austria, Belarus, Belgium, Brunei, Bulgaria, Croatia, Cyprus, the Czech Republic, Denmark, Estonia, Finland, France, Germany, Greece, Hong Kong, Hungary, Iceland, India, Indonesia, Ireland, Israel, Italy, Japan, Jordan, Kuwait, Latvia, Lithuania, Luxembourg, Malaysia, the Netherlands, New Zealand, Norway, Pakistan, the People's Republic of China, the Philippines, Poland, Portugal, Romania, Russia, Saudi Arabia, Singapore, Slovakia, Slovenia, South Africa, South Korea, Spain, Sri Lanka, Sweden, Switzerland, Thailand, Turkey, the United Arab Emirates, the United Kingdom, Ukraine
418872-001	65-watt AC adapter
438523-001	DVD±RW and CD-RW Super Multi Double-Layer Combo Drive (includes bezel and optical drive bracket)
438524-001	DVD±RW/R and CD-RW Double-Layer Combo Drive (includes bezel and optical drive bracket)
438525-001	4200-rpm, 40-GB hard drive (includes bracket and connector)
438526-001	5400-rpm, 60-GB hard drive (includes bracket and connector)
438527-001	PC Card slot bezel
438528-001	Fan assembly
438529-001	Heat sink
438531-001	Keyboard for use in the United States
438531-021	Keyboard for use internationally
438531-031	Keyboard for use in the United Kingdom
438531-041	Keyboard for use in Germany

Spare part number	Description
438531-051	Keyboard for use in France
438531-061	Keyboard for use in Italy
438531-071	Keyboard for use in Spain
438531-081	Keyboard for use in Denmark
438531-091	Keyboard for use in Norway
438531-131	Keyboard for use in Portugal
438531-141	Keyboard for use in Turkey
438531-151	Keyboard for use in Greece
438531-171	Keyboard for use in Saudi Arabia
438531-211	Keyboard for use in Hungary
438531-221	Keyboard for use in the Czech Republic
438531-231	Keyboard for use in Slovakia
438531-241	Keyboard for use in Poland
438531-251	Keyboard for use in Russia
438531-A41	Keyboard for use in Belgium
438531-AR1	Keyboard for use in South Africa
438531-B71	Keyboard for use in Sweden and Finland
438531-BA1	Keyboard for use in Slovenia
438531-BB1	Keyboard for use in Israel
438545-001	1-DIMM, PC2-4200, 256-MB memory module
438546-001	1-DIMM, PC2-4200, 512-MB memory module
438551-001	PC Card assembly
438554-001	Intel Celeron M 360 1.40-GHz processor (includes thermal paste)
438556-001	RTC battery
438557-001	Rubber Feet Kit
440704-001	4-cell, 2.2-Ahr battery
440705-001	Display Label Kit
440706-001	Display Bezel Kit
440707-001	Display Hinge Kit
440708-001	Display Cable Kit
440709-001	Display enclosure for use only with computer models without wireless LAN capability (includes logo)
440710-001	Display enclosure for use only with computer models with wireless LAN capability (includes logo and wireless antenna transceivers and cables)
440711-001	15.4-inch WXGA BrightView display panel

Spare part number	Description
440714-001	Display Screw Kit
440715-001	15.4-inch WXGA BrightView display assembly for use only with computer models without wireless LAN capability (includes wireless antenna transceivers and cables)
440716-001	15.4-inch WXGA BrightView display assembly for use only with computer models with wireless LAN capability
440717-001	Intel Pentium M 770 2.13-GHz processor (includes thermal paste)
441623-001	Switch cover for use only with computer models with wireless LAN capability (includes wireless button and wireless light)
441624-001	Switch cover for use only with computer models without wireless LAN capability
441625-001	Base enclosure (includes 6 rubber feet)
441626-001	Top cover (includes TouchPad and TouchPad cable)
441627-001	Speaker
441628-001	Display inverter
441629-001	Screw Kit
441630-001	Plastics/Hardware Kit
441631-001	Optical drive connector board
441632-001	Button board
441635-001	System board for use only with full-featured computer models
441636-001	System board for use only with defeatured computer models with wireless LAN capability
441637-001	System board for use only with defeatured computer models without wireless LAN capability
441638-001	TouchPad cable
441639-001	Wireless Antenna Kit (includes wireless antenna transceivers and cables)

5 Removal and replacement procedures

Preliminary replacement requirements

Tools required

You will need the following tools to complete the removal and replacement procedures:

- Magnetic screwdriver
- Phillips P0 and P1 screwdrivers
- Flat-bladed screwdriver

Service considerations

The following sections include some of the considerations that you should keep in mind during disassembly and assembly procedures.



NOTE As you remove each subassembly from the computer, place the subassembly (and all accompanying screws) away from the work area to prevent damage.

Plastic parts

Using excessive force during disassembly and reassembly can damage plastic parts. Use care when handling the plastic parts. Apply pressure only at the points designated in the maintenance instructions.

Cables and connectors



CAUTION When servicing the computer, be sure that cables are placed in their proper locations during the reassembly process. Improper cable placement can damage the computer.

Cables must be handled with extreme care to avoid damage. Apply only the tension required to unseat or seat the cables during removal and insertion. Handle cables by the connector whenever possible. In all cases, avoid bending, twisting, or tearing cables. Be sure that cables are routed in such a way that they cannot be caught or snagged by parts being removed or replaced. Handle flex cables with extreme care; these cables tear easily.

Drive handling



CAUTION Drives are fragile components that must be handled with care. To prevent damage to the computer, damage to a drive, or loss of information, observe these precautions:

Before removing or inserting a hard drive, shut down the computer. If you are unsure whether the computer is off or in hibernation, turn the computer on, and then shut it down through the operating system.

Before handling a drive, be sure that you are discharged of static electricity. While handling a drive, avoid touching the connector.

Before removing a diskette drive or optical drive, be sure that a diskette or disc is not in the drive and be sure that the optical drive tray is closed.

Handle drives on surfaces covered with at least one inch of shock-proof foam.

Avoid dropping drives from any height onto any surface.

After removing a hard drive, an optical drive, or a diskette drive, place it in a static-proof bag.

Avoid exposing a hard drive to products that have magnetic fields, such as monitors or speakers.

Avoid exposing a drive to temperature extremes or liquids.

If a drive must be mailed, place the drive in a bubble pack mailer or other suitable form of protective packaging and label the package “FRAGILE.”

Grounding guidelines

Electrostatic discharge damage

Electronic components are sensitive to electrostatic discharge (ESD). Circuitry design and structure determine the degree of sensitivity. Networks built into many integrated circuits provide some protection, but in many cases, ESD contains enough power to alter device parameters or melt silicon junctions.

A discharge of static electricity from a finger or other conductor can destroy static-sensitive devices or microcircuitry. Even if the spark is neither felt nor heard, damage may have occurred.

An electronic device exposed to ESD may not be affected at all and can work perfectly throughout a normal cycle. Or the device may function normally for a while, then degrade in the internal layers, reducing its life expectancy.



CAUTION To prevent damage to the computer when you are removing or installing internal components, observe these precautions:

Keep components in their electrostatic-safe containers until you are ready to install them.

Use nonmagnetic tools.

Before touching an electronic component, discharge static electricity by using the guidelines described in this section.

Avoid touching pins, leads, and circuitry. Handle electronic components as little as possible.

If you remove a component, place it in an electrostatic-safe container.

The following table shows how humidity affects the electrostatic voltage levels generated by different activities.



CAUTION A product can be degraded by as little as 700 V.

Typical electrostatic voltage levels

Event	Relative humidity		
	10%	40%	55%
Walking across carpet	35,000 V	15,000 V	7,500 V
Walking across vinyl floor	12,000 V	5,000 V	3,000 V
Motions of bench worker	6,000 v	800 V	400 V
Removing DIPS from plastic tube	2,000 V	700 V	400 V
Removing DIPS from vinyl tray	11,500 V	4,000 V	2,000 V
Removing DIPS from Styrofoam	14,500 V	5,000 V	3,500 V
Removing bubble pack from PCB	26,500 V	20,000 V	7,000 V
Packing PCBs in foam-lined box	21,000 V	11,000 V	5,000 V

Packaging and transporting guidelines

Follow these grounding guidelines when packaging and transporting equipment:

- To avoid hand contact, transport products in static-safe tubes, bags, or boxes.
- Protect ESD-sensitive parts and assemblies with conductive or approved containers or packaging.
- Keep ESD-sensitive parts in their containers until the parts arrive at static-free workstations.
- Place items on a grounded surface before removing items from their containers.
- Always be properly grounded when touching a component or assembly.
- Store reusable ESD-sensitive parts from assemblies in protective packaging or nonconductive foam.
- Use transporters and conveyors made of antistatic belts and roller bushings. Be sure that mechanized equipment used for moving materials is wired to ground and that proper materials are selected to avoid static charging. When grounding is not possible, use an ionizer to dissipate electric charges.

Workstation guidelines

Follow these grounding workstation guidelines:

- Cover the workstation with approved static-shielding material.
- Use a wrist strap connected to a properly grounded work surface and use properly grounded tools and equipment.
- Use conductive field service tools, such as cutters, screwdrivers, and vacuums.
- When fixtures must directly contact dissipative surfaces, use fixtures made only of static-safe materials.
- Keep the work area free of nonconductive materials, such as ordinary plastic assembly aids and Styrofoam.
- Handle ESD-sensitive components, parts, and assemblies by the case or PCM laminate. Handle these items only at static-free workstations.
- Avoid contact with pins, leads, or circuitry.
- Turn off power and input signals before inserting or removing connectors or test equipment.

Equipment guidelines

Grounding equipment must include either a wrist strap or a foot strap at a grounded workstation.

- When seated, wear a wrist strap connected to a grounded system. Wrist straps are flexible straps with a minimum of one megohm $\pm 10\%$ resistance in the ground cords. To provide proper ground, wear a strap snugly against the skin at all times. On grounded mats with banana-plug connectors, use alligator clips to connect a wrist strap.
- When standing, use foot straps and a grounded floor mat. Foot straps (heel, toe, or boot straps) can be used at standing workstations and are compatible with most types of shoes or boots. On conductive floors or dissipative floor mats, use foot straps on both feet with a minimum of one megohm resistance between the operator and ground. To be effective, the conductive strips must be worn in contact with the skin.

The following grounding equipment is recommended to prevent electrostatic damage:

- Antistatic tape
- Antistatic smocks, aprons, and sleeve protectors
- Conductive bins and other assembly or soldering aids
- Nonconductive foam
- Conductive tabletop workstations with ground cords of one megohm resistance
- Static-dissipative tables or floor mats with hard ties to the ground
- Field service kits
- Static awareness labels
- Material-handling packages
- Nonconductive plastic bags, tubes, or boxes
- Metal tote boxes
- Electrostatic voltage levels and protective materials

The following table lists the shielding protection provided by antistatic bags and floor mats.

Material	Use	Voltage protection level
Antistatic plastic	Bags	1,500 V
Carbon-loaded plastic	Floor mats	7,500 V
Metallized laminate	Floor mats	5,000 V

Component replacement procedures

This chapter provides removal and replacement procedures.

There are as many as 56 screws, in 6 different sizes, that must be removed, replaced, or loosened when servicing the computer. Make special note of each screw and screw lock size and location during removal and replacement.

Serial number

Report the computer serial number to HP when requesting information or ordering spare parts. The serial number is located on the bottom of the computer.



Battery

Description	Spare part number
4-cell, 2.2-Ahr battery	440704-001

Before disassembling the computer, follow these steps:

1. Shut down the computer. If you are unsure whether the computer is off or in hibernation, turn the computer on, and then shut it down through the operating system.
2. Disconnect all external devices connected to the computer.
3. Disconnect the power cord.

Remove the battery:

1. Turn the computer upside down, with the rear panel toward you.
2. Slide the battery release latches (1) toward the inside of the computer. (The battery disengages from the computer.)
3. Remove the battery (2) by pulling it straight back and away from the computer.

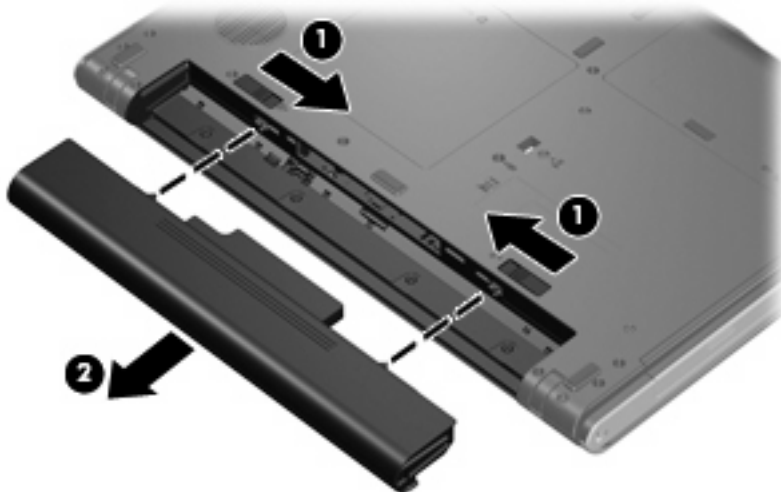

Install the battery by inserting it into the battery bay until you hear an audible click.

Hard drive

Description	Spare part number
5400-rpm, 60-GB	438526-001
4200-rpm, 40-GB	438525-001

Before disassembling the computer, follow these steps:

1. Shut down the computer. If you are unsure whether the computer is off or in hibernation, turn the computer on, and then shut it down through the operating system.
2. Disconnect all external devices connected to the computer.
3. Disconnect the power cord.
4. Remove the battery (see [Battery on page 29](#)).

Remove the hard drive:

1. Position the computer with the front toward you.
2. Loosen the two Phillips PM2.5×6.0 screws **(1)** that secure the hard drive cover to the computer.
3. Lift the left side of the hard drive cover **(2)** and swing it to right.



4. Remove the hard drive cover.



NOTE The hard drive cover is included in the Plastics/Hardware Kit, spare part number 441630-001.

5. Grasp the Mylar tab **(1)** on the hard drive and pull the hard drive **(2)** to the left to disconnect it from the system board.

6. Remove the hard drive (3) from the hard drive bay.

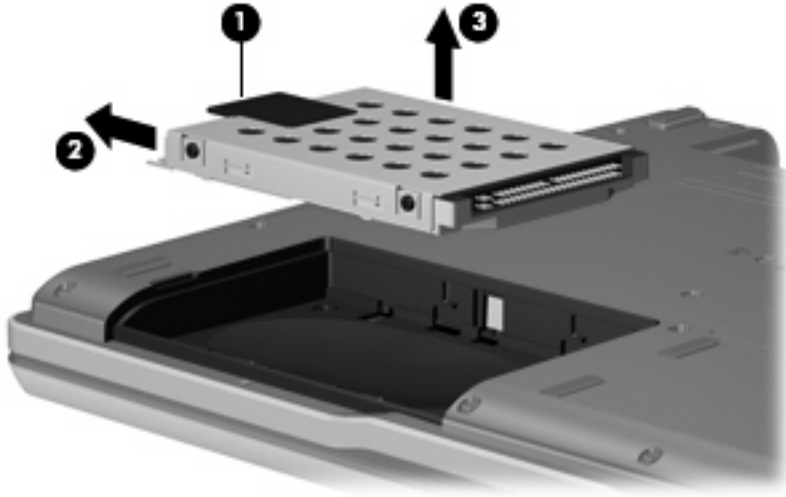

7. If it is necessary to remove the hard drive bracket from the hard drive, remove the four Phillips PM3.0×3.0 hard drive bracket screws (1) from each side of the hard drive.
8. Lift the bracket (2) straight up to remove it from the hard drive.

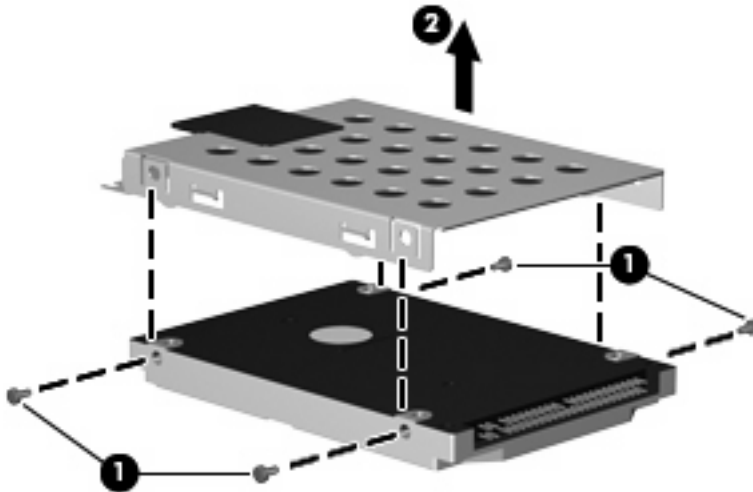

Reverse this procedure to reassemble and install the hard drive.

Computer feet

Description	Spare part number
Rubber Feet Kit	438557-001

The computer feet are adhesive-backed rubber pads.

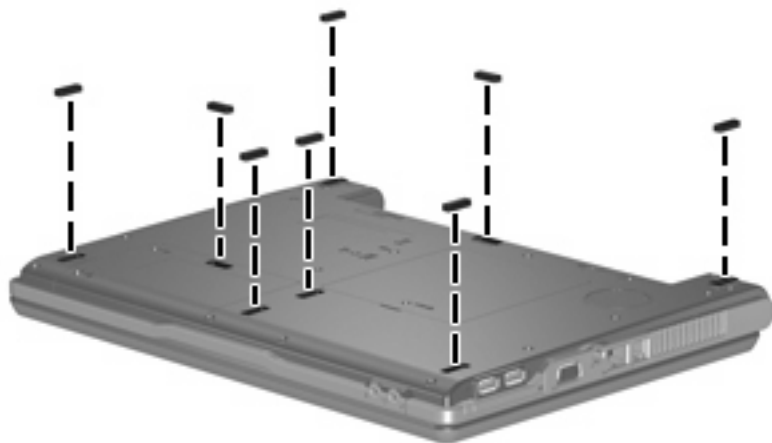

Memory module

Description	Spare part number
1-DIMM, PC2-4200, 512-MB	438546-001
1-DIMM, PC2-4200, 256-MB	438545-001

Before removing the memory module, follow these steps:

1. Shut down the computer. If you are unsure whether the computer is off or in hibernation, turn the computer on, and then shut it down through the operating system.
2. Disconnect all external devices connected to the computer.
3. Disconnect the power cord.
4. Remove the battery (see [Battery on page 29](#)).

Remove the external memory module:

1. Position the computer with the rear panel toward you.
2. Loosen the Phillips PM2.5×6.0 screw **(1)** that secures the memory/Mini PCI card module compartment cover to the computer.

3. Lift the front edge of the cover (2) and swing it toward you.

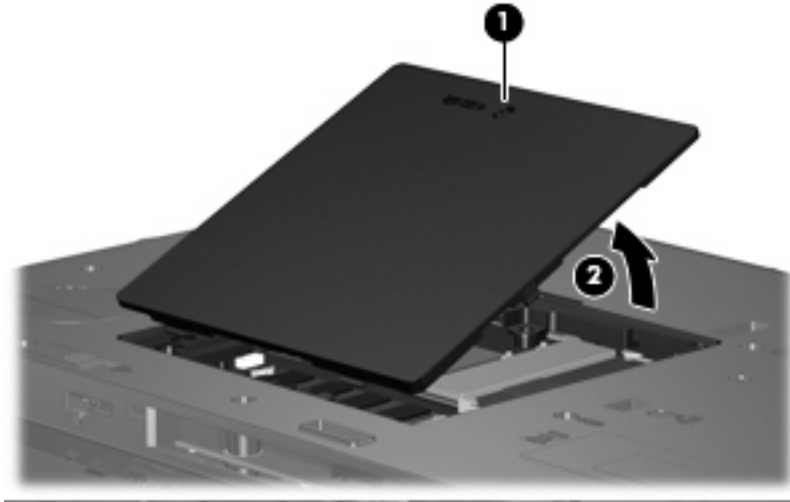

4. Remove the memory/Mini PCI card module compartment cover.



NOTE The memory/Mini PCI card module compartment cover is included in the Plastics/Hardware Kit, spare part number 441630-001 .

5. Spread the retaining tabs (1) on each side of the memory module socket to release the memory module. (The edge of the module opposite the socket rises away from the computer.)
6. Remove the memory module (2) by pulling the module away from the socket at an angle.



NOTE Memory modules are designed with a notch (3) to prevent incorrect installation into the memory module socket.

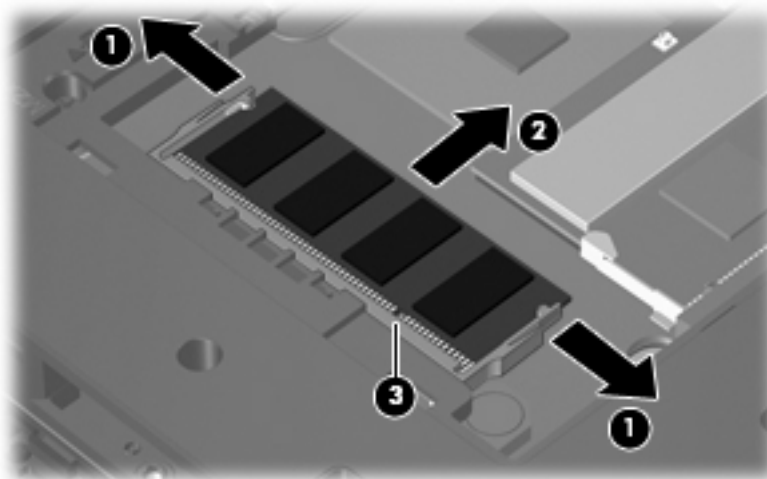

Reverse this procedure to install a memory module.

Mini PCI card module

Description	Spare part number		
802.11b/g Mini PCI card WLAN module for use in the MOW countries or regions listed below.	390501-001		
Argentina	Canada	Mexico	The United States
Brazil	Chile	Taiwan	
802.11b/g Mini PCI card WLAN module for use in the ROW countries or regions listed below.	390501-002		
Australia	Greece	Luxembourg	Slovakia
Austria	Hong Kong	Malaysia	Slovenia
Belarus	Hungary	The Netherlands	South Africa
Belgium	Iceland	New Zealand	South Korea
Brunei	India	Norway	Spain
Bulgaria	Indonesia	Pakistan	Sri Lanka
Croatia	Ireland	The People's Republic of China	Sweden
Cyprus	Israel	The Philippines	Switzerland
The Czech Republic	Italy	Poland	Thailand
Denmark	Japan	Portugal	Turkey
Estonia	Jordan	Romania	The United Arab Emirates
Finland	Kuwait	Russia	The United Kingdom
France	Latvia	Saudi Arabia	Ukraine
Germany	Lithuania	Singapore	

Before removing the Mini PCI card module, follow these steps:

1. Shut down the computer. If you are unsure whether the computer is off or in hibernation, turn the computer on, and then shut it down through the operating system.
2. Disconnect all external devices connected to the computer.
3. Disconnect the power cord.
4. Remove the battery (see [Battery on page 29](#)).
5. Remove the memory/Mini PCI card module compartment cover (see [Memory module on page 32](#)).

Remove the Mini PCI card module:

1. Disconnect the WLAN antenna cables (1) from the terminals on the WLAN module.



NOTE The wireless antenna cables are available in the Wireless Antenna Kit, spare part number 441639-001.

NOTE The black WLAN antenna cable is connected to the WLAN module “Main” terminal. The gray WLAN antenna cable is connected to the WLAN module “Aux” terminal.

2. Spread the retaining tabs (2) on each side of the Mini PCI card module socket to release the Mini PCI card module. (The edge of the module opposite the socket rises away from the computer.)
3. Remove the Mini PCI card module (3) by pulling the module away from the socket at an angle.



NOTE Mini PCI card modules are designed with a notch (4) to prevent incorrect installation.

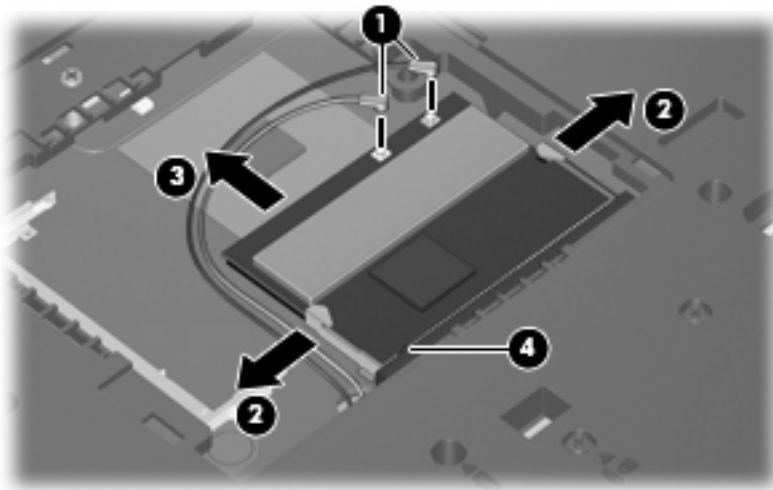

Reverse this procedure to install a Mini PCI card module.

Optical drive



NOTE All optical drive spare part kits include an optical drive bezel and optical drive bracket.

Description	Spare part number
DVD±RW and CD-RW Super Multi Double-Layer Combo Drive	438523-001
DVD±RW/R and CD-RW Double-Layer Combo Drive	438524-001

Before removing the optical drive, follow these steps:

1. Shut down the computer. If you are unsure whether the computer is off or in hibernation, turn the computer on, and then shut it down through the operating system.
2. Disconnect all external devices connected to the computer.
3. Disconnect the power cord.
4. Remove the battery (see [Battery on page 29](#)).
5. Remove the memory/Mini PCI card module compartment cover (see [Memory module on page 32](#)).

Remove the optical drive:

1. Position the computer with left side toward you.
2. Remove the Phillips PM2.0×9.0 screw **(1)** that secures the optical drive to the computer.
3. Use a flat-bladed tool to push the metal tab **(2)** toward the left side of the computer. (The optical drive partially removes from the optical drive bay.)
4. Remove the optical drive **(3)** from the computer.

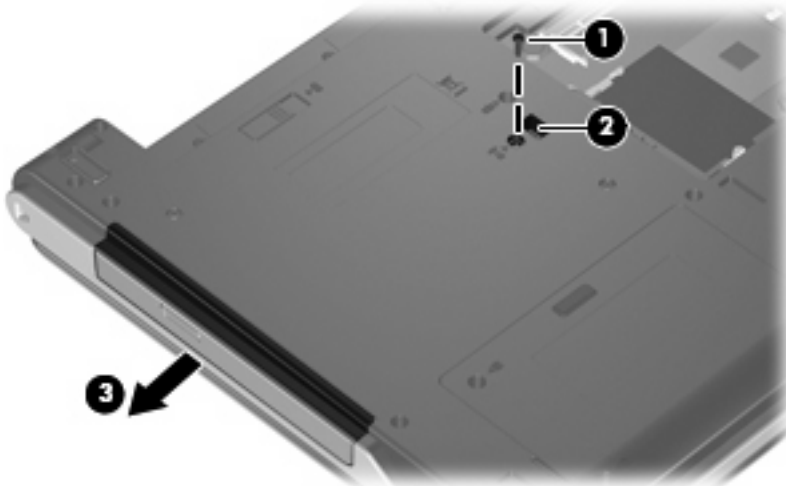

5. If it is necessary to replace the optical drive bracket, remove the two Phillips PM2.0×3.0 screws **(1)** that secure the bracket to the optical drive.

6. Remove the optical drive bracket (2).

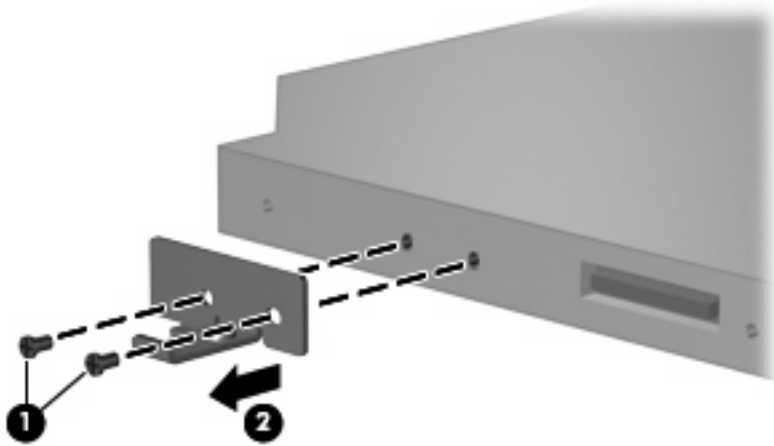

Reverse this procedure to reassemble and install the optical drive.

Switch cover

Description	Spare part number
For use only with computer models with wireless LAN capability (includes wireless button and wireless light)	441623-001
For use only with computer models without wireless LAN capability	441624-001

Before removing the switch cover, follow these steps:

1. Shut down the computer. If you are unsure whether the computer is off or in hibernation, turn the computer on, and then shut it down through the operating system.
2. Disconnect all external devices connected to the computer.
3. Disconnect the power cord.
4. Remove the battery (see [Battery on page 29](#)).

Remove the switch cover:

1. Turn the computer upside down, with the rear panel toward you.
2. Remove the seven Phillips PM2.0×9.0 screws **(1)** and the four Phillips PM2.0×2.0 screws **(2)** that secure the switch cover to the computer.

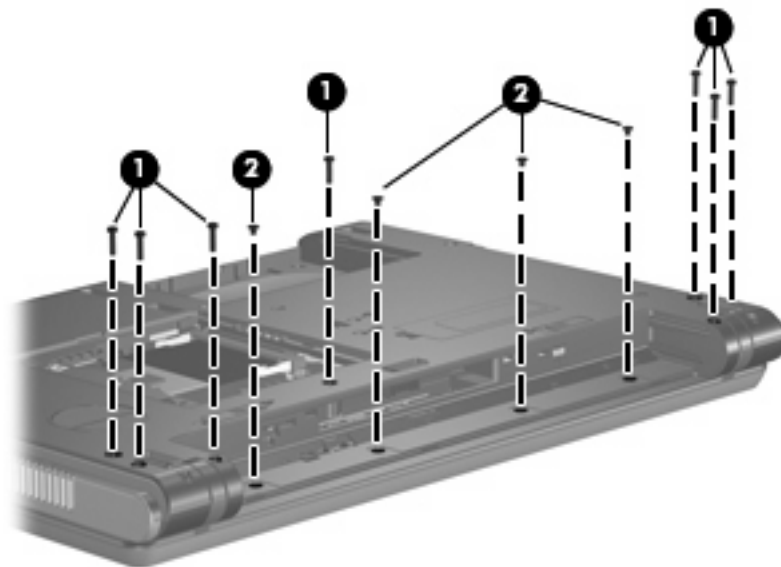

3. Turn the computer display-side up, with front toward you.
4. Open the computer as far as possible.

5. Lift the rear edge of the switch cover and swing it forward.



6. Remove the switch cover.

Reverse this procedure to install the switch cover.

Keyboard

Description			
Belgium	438531-A41	Portugal	438531-131
The Czech Republic	438531-221	Russia	438531-251
Denmark	438531-081	Saudi Arabia	438531-171
Europe	438531-021	Slovakia	438531-231
France	438531-051	Slovenia	438531-BA1
Germany	438531-041	South Africa	438531-AR1
Greece	438531-151	Spain	438531-061
Hungary	438531-211	Sweden and Finland	438531-B71
Israel	438531-BB1	Turkey	438531-141
Italy	438531-061	The United Kingdom	438531-031
Norway	438531-091	The United States	438531-001
Poland	438531-241		

Before removing the keyboard, follow these steps:

1. Shut down the computer. If you are unsure whether the computer is off or in hibernation, turn the computer on, and then shut it down through the operating system.
2. Disconnect all external devices connected to the computer.
3. Disconnect the power cord.
4. Remove the battery (see [Battery on page 29](#)).
5. Remove the memory/Mini PCI card module compartment cover (see [Memory module on page 32](#)).
6. Remove the switch cover (see [Switch cover on page 38](#)).

Remove the keyboard:

1. Position the computer with the front toward you.

2. Remove the two Phillips PM2.0×9.0 screws that secure the keyboard to the computer.

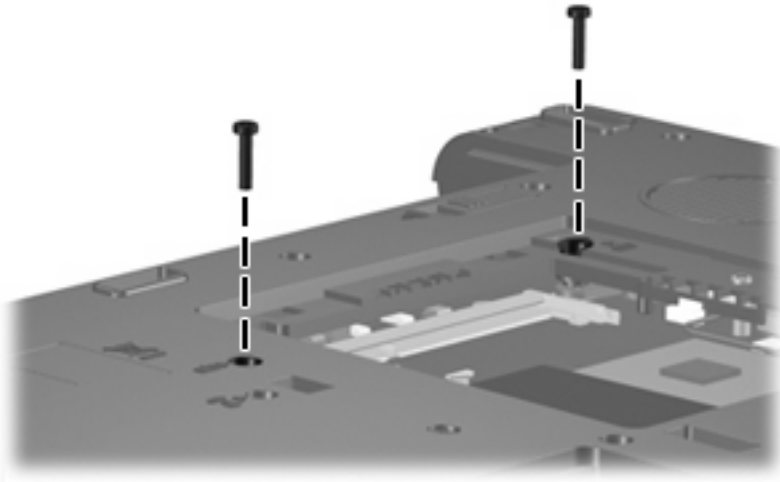

3. Turn the computer display-side up, with the front toward you.
4. Open the computer as far as possible.
5. Lift the rear edge of the keyboard and swing it toward you until it rests on the palm rest.



6. Release the zero insertion force (ZIF) connector **(1)** to which the keyboard cable is attached and disconnect the keyboard cable **(2)** from the system board.

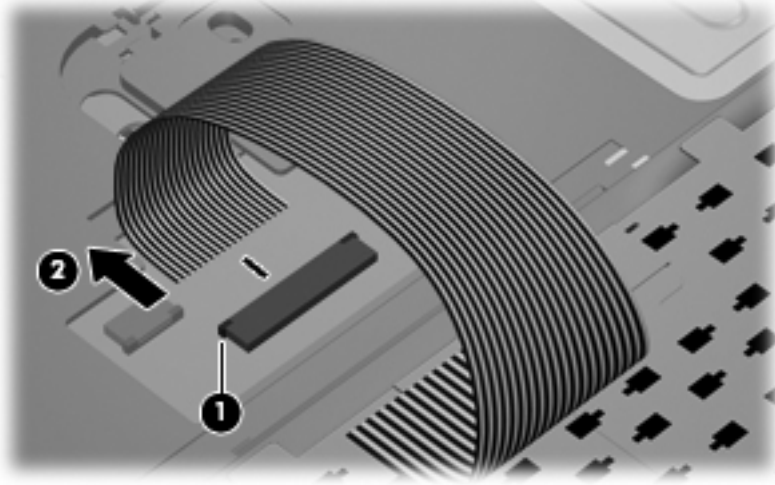

7. Remove the keyboard.

Reverse this procedure to install the keyboard.

Button board

Description	Spare part number
Button board	441631-001

Before removing the button board, follow these steps:

1. Shut down the computer. If you are unsure whether the computer is off or in hibernation, turn the computer on, and then shut it down through the operating system.
2. Disconnect all external devices connected to the computer.
3. Disconnect the power cord.
4. Remove the battery (see [Battery on page 29](#)).
5. Remove the memory/Mini PCI card module compartment cover (see [Memory module on page 32](#)).
6. Remove the following components:
 - a. Switch cover (see [Switch cover on page 38](#))
 - b. Keyboard (see [Keyboard on page 40](#))

Remove the button board:

1. Release the ZIF connector (1) to which the button board cable is connected and disconnect the cable (2) from the system board.
2. Remove the Phillips PM2.0×3.0 screw (3) that secures the button board to the computer.
3. Remove the button board (4).

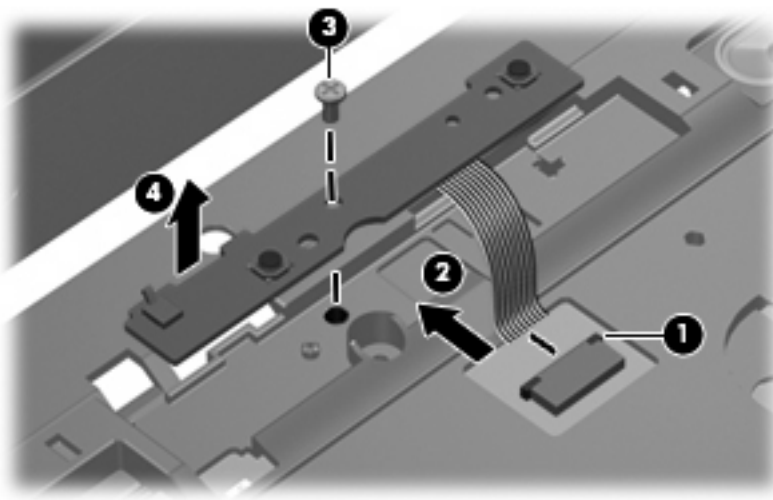

Reverse this procedure to reassemble and install the button board.

Display assembly

Description	Spare part number
15.4-inch, WXGA BrightView display assembly for use only with computer models with wireless LAN capability (includes wireless antenna transceivers and cables)	440716-001
15.4-inch, WXGA BrightView display assembly for use only with computer models without wireless LAN capability	440715-001

Before removing the display assembly, follow these steps:

1. Shut down the computer. If you are unsure whether the computer is off or in hibernation, turn the computer on, and then shut it down through the operating system.
2. Disconnect all external devices connected to the computer.
3. Disconnect the power cord.
4. Remove the battery (see [Battery on page 29](#)).
5. Remove the memory/Mini PCI card module compartment cover (see [Memory module on page 32](#)) and disconnect the wireless antenna cables from the Mini PCI card module (see [Mini PCI card module on page 34](#)).
6. Remove the following components:
 - a. Switch cover (see [Switch cover on page 38](#))
 - b. Keyboard (see [Keyboard on page 40](#))

Remove the display assembly:

1. Close the computer and turn it upside down with the rear panel toward you.
2. Remove the two Phillips PM2.0×7.0 screws that secure the display assembly to the computer.

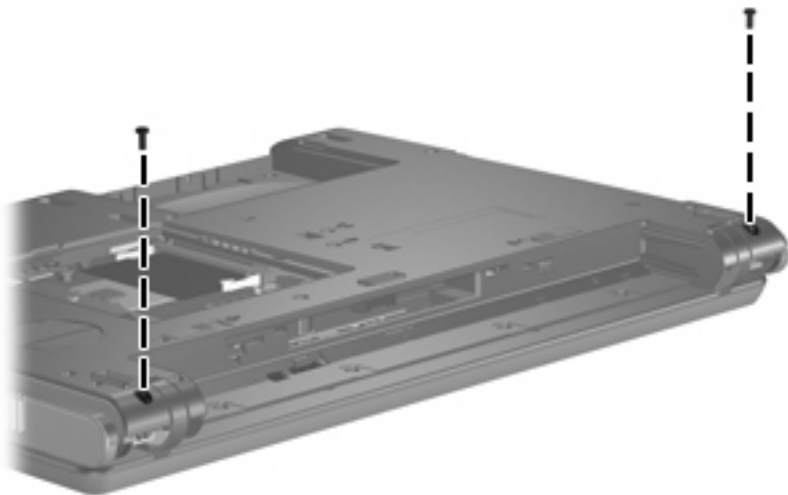

3. Turn the computer display-side up, with the front toward you.
4. Open the computer until the display assembly is in an upright position.

5. Disconnect the display cable connector **(1)** from the system board and remove the display cable **(2)** from the clips and routing channel built into the top cover.
6. Remove the wireless antenna cables **(3)** from the clips and routing channel built into the top cover.
7. Remove the two Phillips PM2.0×9.0 screws **(4)** that secure the display assembly to the computer.

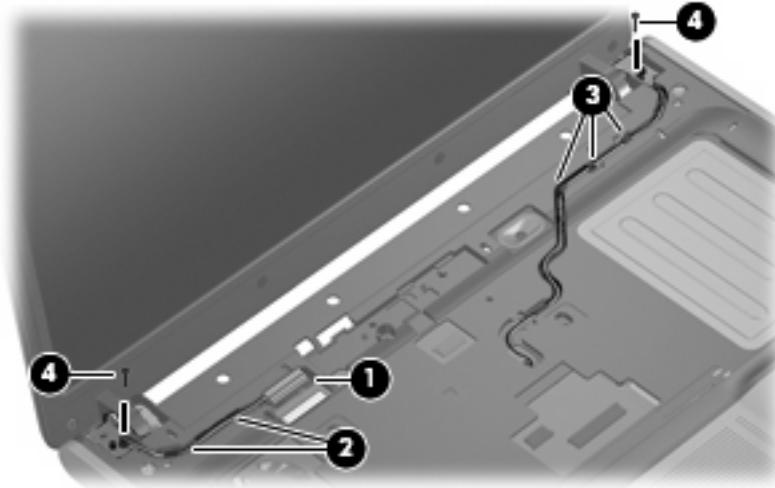

8. Lift the display assembly straight up and remove it.



9. If it is necessary to replace any of the display assembly internal subcomponents, remove the following display bezel screw covers and screws:

- (1) Four round rubber screw covers on the top edge of the display bezel
- (2) Four flat rubber screw covers on the bottom edge of the display bezel
- (3) Eight Phillips PM2.5×6.0 screws



NOTE The display bezel screw covers are available in the Display Screw Cover Kit, spare part number DSCK-001. All screws used to secure display assembly internal subcomponents are available in the Display Screw Kit, spare part number 404714-001.

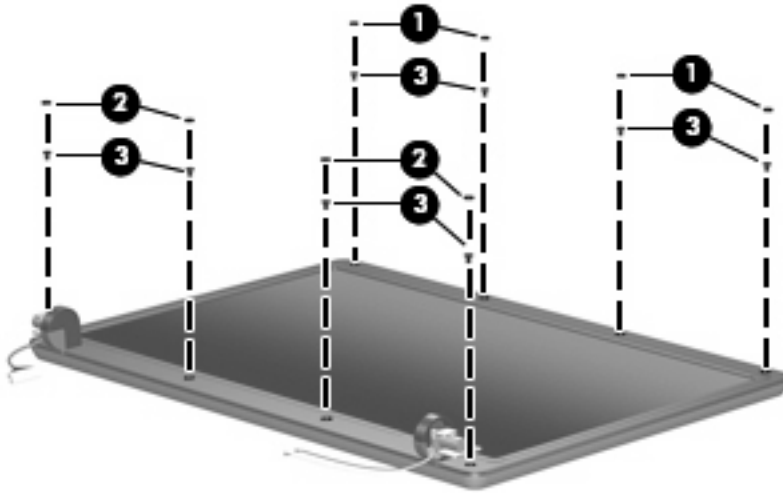

10. Flex the inside edges of the left and right sides (1) of the display bezel and the inside edges of the top and bottom sides (2) of the display bezel until the bezel disengages from the display assembly.

11. Remove the display bezel (3).



NOTE The display bezel is available using spare part number 440706-001.

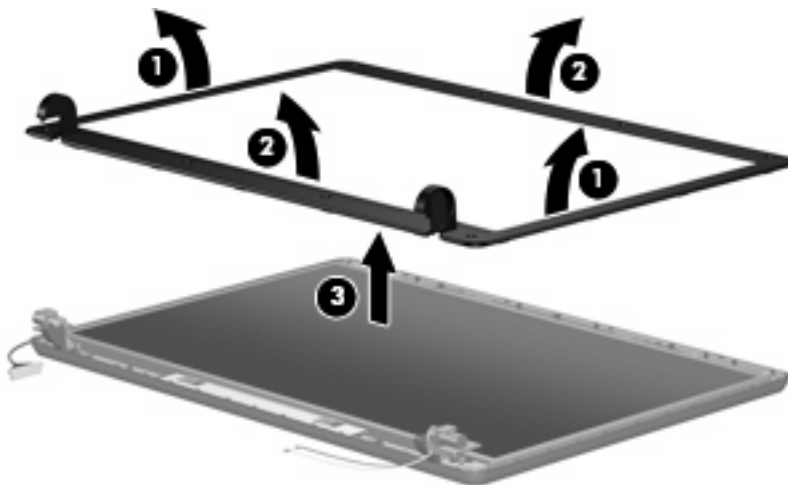

12. If it is necessary to replace the display inverter, disconnect the display panel cable (1) and the backlight cable (2) from the inverter.
13. Remove the display inverter (3).



NOTE The display inverter is available using spare part number 441628-001.

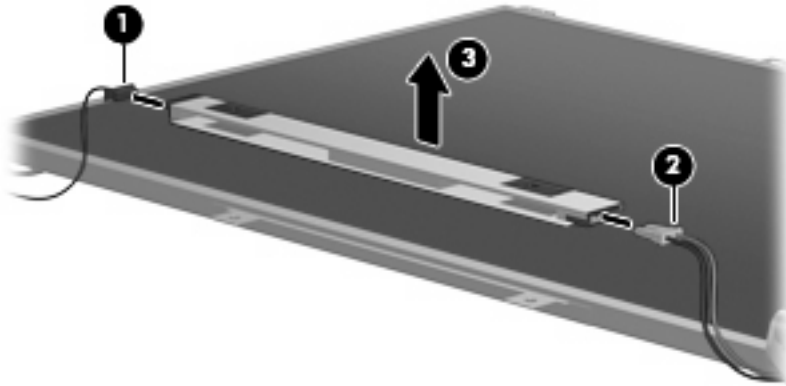

14. If it is necessary to replace the display panel, remove the four Phillips PM2.5×6.0 screws (1) that secure the panel to the display enclosure.
15. Remove the display panel (2).



NOTE The display panel is available using spare part number 440711-001.

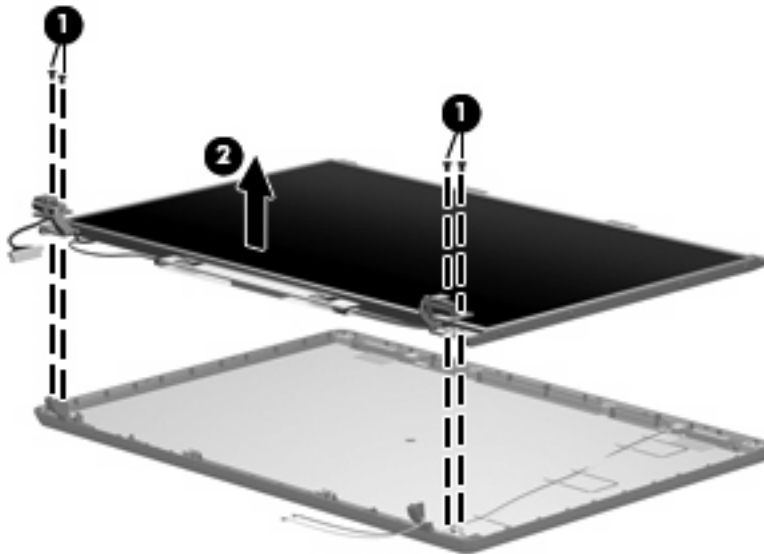

16. If it is necessary to replace either of the display hinges, remove the four Phillips PM2.0×3.0 screws (1) that secure each hinge to the display panel.

17. Remove the display hinges (2).



NOTE The display hinges are available in the Display Hinge Kit, spare part number 440707-001.

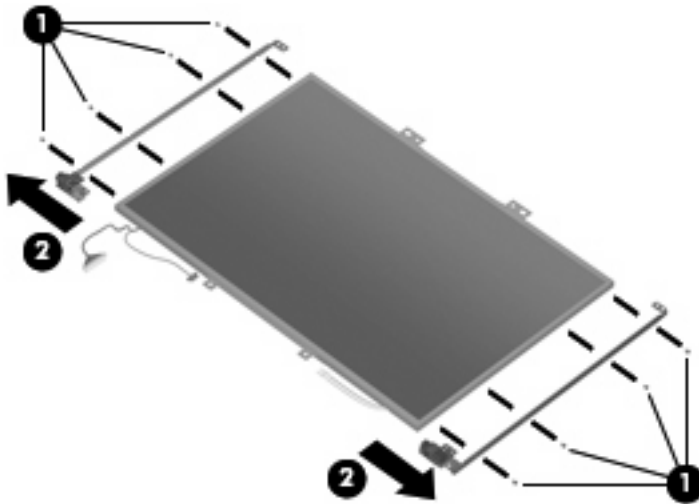

18. If it is necessary to replace the wireless antenna transceivers, remove the Phillips PM2.5×4.0 screws (1) that secure each transceiver (2) to the display enclosure.



NOTE The wireless antenna transceivers are also attached to the display enclosure with a thin layer of adhesive. It may be necessary to use a flat-bladed tool to pry the transceivers away from the display enclosure.

19. Remove the wireless antenna transceivers (2) and cables (3) from the display enclosure.



NOTE The wireless antenna cables are attached to the display enclosure by a series of pliable tabs (4) built into the enclosure shielding. Lift the tabs to release the cables.

NOTE The wireless antenna transceivers and cables are available in the Wireless Antenna Kit, spare part number 441639-001.

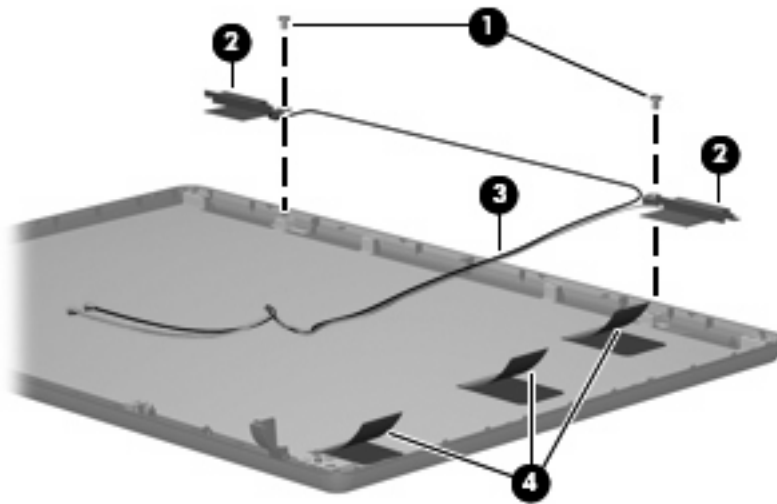

Reverse this procedure to reassemble and install the display assembly.

Base enclosure

Description	Spare part number
Base enclosure	441625-001

Before removing the base enclosure, follow these steps:

1. Shut down the computer. If you are unsure whether the computer is off or in hibernation, turn the computer on, and then shut it down through the operating system.
2. Disconnect all external devices connected to the computer.
3. Disconnect the power cord.
4. Remove the battery (see [Battery on page 29](#)).
5. Remove the following components:
 - a. Hard drive (see [Hard drive on page 30](#))
 - b. Memory/Mini PCI card module compartment cover (see [Memory module on page 32](#))
 - c. Optical drive (see [Optical drive on page 36](#))
 - d. Switch cover (see [Switch cover on page 38](#))
 - e. Keyboard (see [Keyboard on page 40](#))
 - f. Display assembly (see [Display assembly on page 44](#))

Remove the base enclosure:

1. Release the ZIF connector (1) to which the TouchPad cable is attached and disconnect the TouchPad cable (2) from the system board.

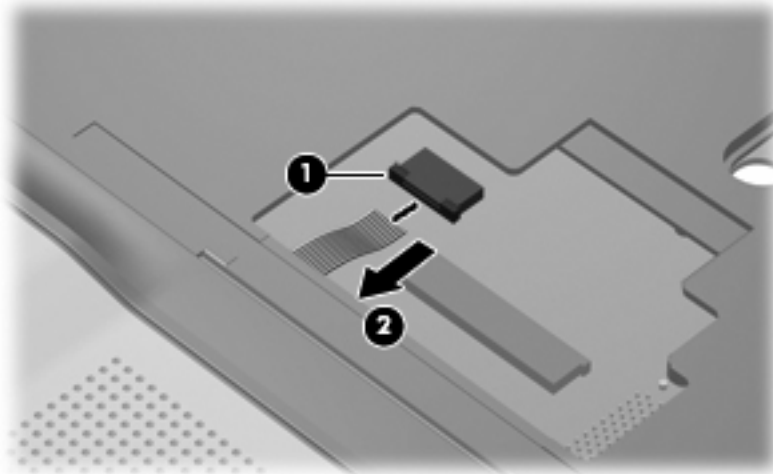

2. Turn the computer upside down, with the front toward you.

3. Remove the two Phillips PM2.0×3.0 screws (1) and the twelve Phillips PM2.0×9.0 screws (2) that secure the base enclosure to the computer.

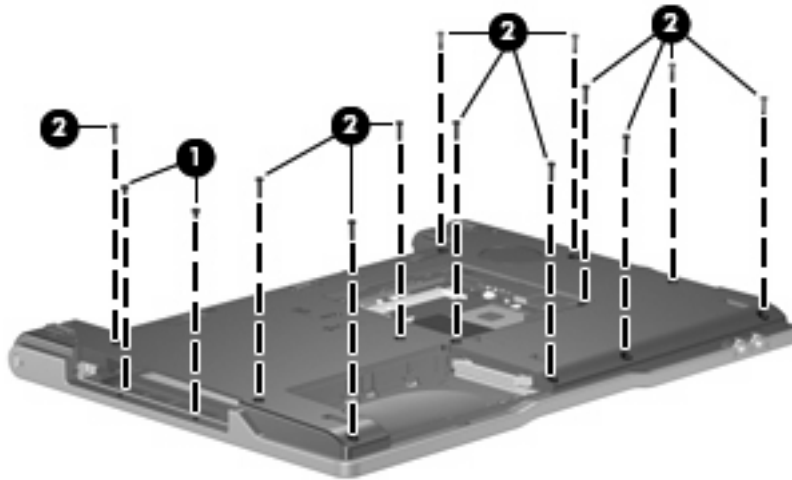

4. Lift the left side of the base enclosure (1) until the USB connectors (2) disengage from their openings in the base enclosure.



5. Remove the base enclosure.

Reverse this procedure to install the base enclosure.

RTC battery

Description	Spare part number
RTC battery	438556-001

Before removing the RTC battery, follow these steps:

1. Shut down the computer. If you are unsure whether the computer is off or in hibernation, turn the computer on, and then shut it down through the operating system.
2. Disconnect all external devices connected to the computer.
3. Disconnect the power cord.
4. Remove the battery (see [Battery on page 29](#)).
5. Remove the following components:
 - a. Hard drive (see [Hard drive on page 30](#))
 - b. Memory/Mini PCI card module compartment cover (see [Memory module on page 32](#))
 - c. Optical drive (see [Optical drive on page 36](#))
 - d. Switch cover (see [Switch cover on page 38](#))
 - e. Keyboard (see [Keyboard on page 40](#))
 - f. Display assembly (see [Display assembly on page 44](#))
 - g. Base enclosure (see [Base enclosure on page 49](#))

Remove the RTC battery:

- ▲ Use a non-conductive, flat-bladed tool to pry the RTC battery out of the socket.

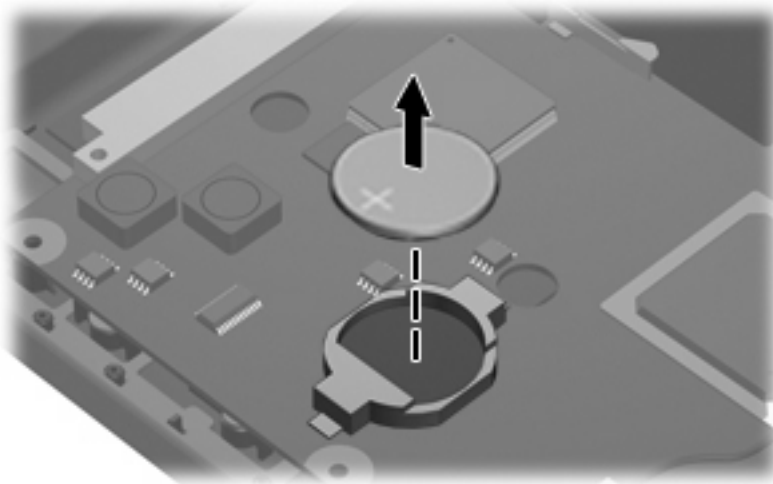

Reverse this procedure to install the RTC battery. Be sure the RTC battery is installed with the “+” sign facing up.

Fan assembly

Description	Spare part number
Fan assembly	438528-001

Before removing the fan assembly, follow these steps:

1. Shut down the computer. If you are unsure whether the computer is off or in hibernation, turn the computer on, and then shut it down through the operating system.
2. Disconnect all external devices connected to the computer.
3. Disconnect the power cord.
4. Remove the battery (see [Battery on page 29](#)).
5. Remove the following components:
 - a. Hard drive (see [Hard drive on page 30](#))
 - b. Memory/Mini PCI card module compartment cover (see [Memory module on page 32](#))
 - c. Optical drive (see [Optical drive on page 36](#))
 - d. Switch cover (see [Switch cover on page 38](#))
 - e. Keyboard (see [Keyboard on page 40](#))
 - f. Display assembly (see [Display assembly on page 44](#))
 - g. Base enclosure (see [Base enclosure on page 49](#))

Remove the fan assembly:

1. Disconnect the fan cable (1) from the system board.
2. Remove the Phillips PM2.0×9.0 screw (2) that secures the fan assembly to the top cover.
3. Remove the fan assembly (3).

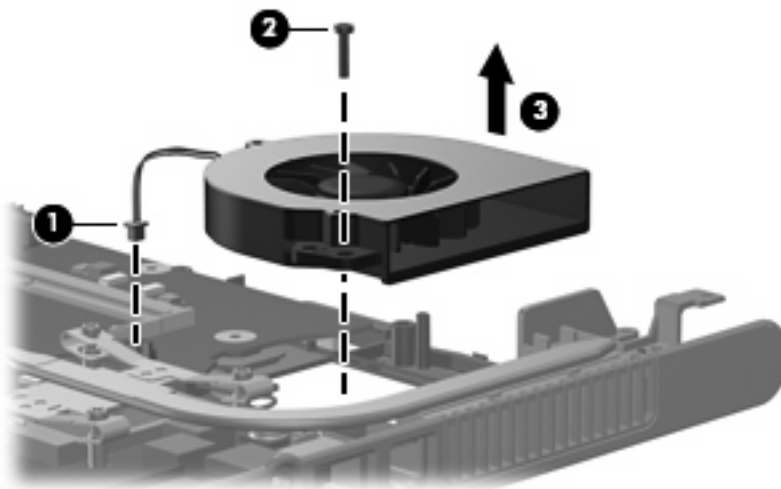

Reverse this procedure to install the fan assembly.



NOTE To properly ventilate the computer, allow at least a 7.6-cm (3-inch) clearance on the left and right sides of the computer.

The computer uses an electric fan for ventilation. The fan is controlled by a temperature sensor and is designed to turn on automatically when high temperature conditions exist. These conditions are affected by high external temperatures, system power consumption, power management/battery conservation configurations, battery fast charging, and software applications. Exhaust air is displaced through the ventilation grill located on the left side of the computer.

Heat sink

Description	Spare part number
Heat sink (includes thermal paste)	438529-001

Before removing the heat sink, follow these steps:

1. Shut down the computer. If you are unsure whether the computer is off or in hibernation, turn the computer on, and then shut it down through the operating system.
2. Disconnect all external devices connected to the computer.
3. Disconnect the power cord.
4. Remove the battery (see [Battery on page 29](#)).
5. Remove the following components:
 - a. Hard drive (see [Hard drive on page 30](#))
 - b. Memory/Mini PCI card module compartment cover (see [Memory module on page 32](#))
 - c. Optical drive (see [Optical drive on page 36](#))
 - d. Switch cover (see [Switch cover on page 38](#))
 - e. Keyboard (see [Keyboard on page 40](#))
 - f. Display assembly (see [Display assembly on page 44](#))
 - g. Base enclosure (see [Base enclosure on page 49](#))
 - h. Fan assembly (see [Fan assembly on page 52](#))

Remove the heat sink:

1. Remove the four Phillips PM2.5×6.0 screws **(1)** that secure the heat sink to the system board.
2. Slide the heat sink **(2)** to the left until the right side of the heat sink clears the top cover.



NOTE Due to the adhesive quality of the thermal paste located between the heat sink and processor, it may be necessary to move the heat sink from side to side to detach the heat sink from the processor.

3. Lift the left side of the heat sink (3) and remove it.

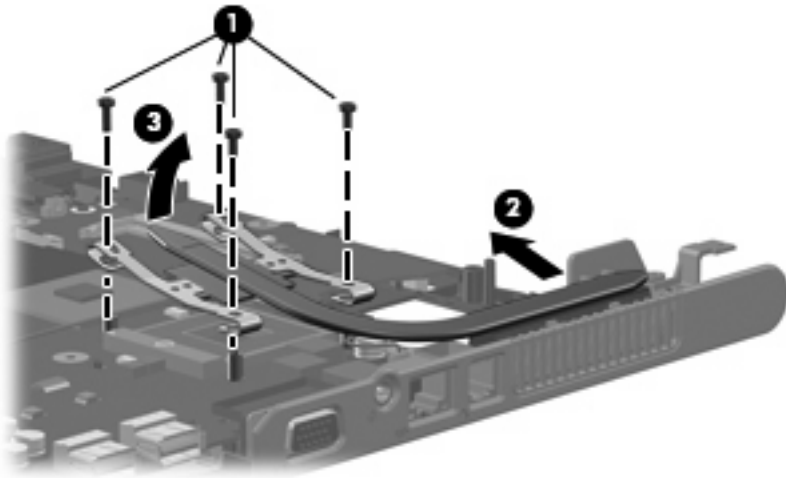

NOTE The thermal paste should be thoroughly cleaned from the surfaces of the processor (1) and heat sink (2) each time the heat sink is removed. Thermal paste is included with all heat sink and processor spare part kits.

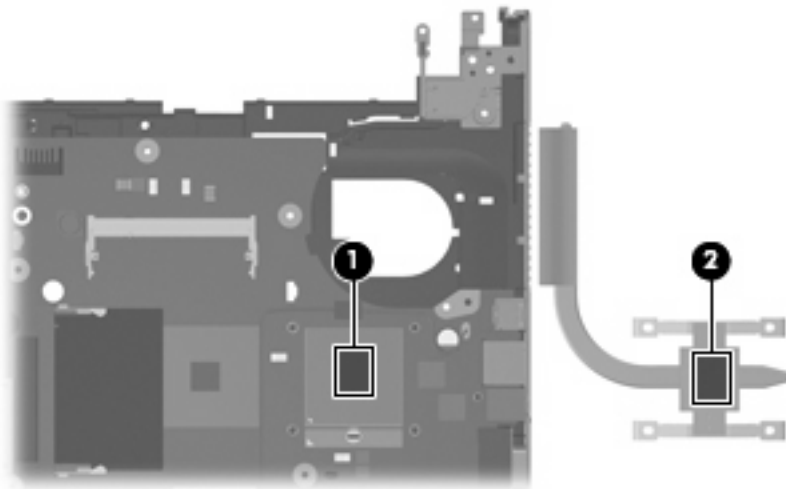

Reverse this procedure to install the heat sink.

Processor



NOTE All processor spare part kits include thermal paste.

Description	Spare part number
Intel Pentium M 770 2.13-GHz processor	440717-001
Intel Celeron M 360 1.40-GHz processor	438554-001

Before removing the processor, follow these steps:

1. Shut down the computer. If you are unsure whether the computer is off or in hibernation, turn the computer on, and then shut it down through the operating system.
2. Disconnect all external devices connected to the computer.
3. Disconnect the power cord.
4. Remove the battery (see [Battery on page 29](#)).
5. Remove the following components:
 - a. Hard drive (see [Hard drive on page 30](#))
 - b. Memory/Mini PCI card module compartment cover (see [Memory module on page 32](#))
 - c. Optical drive (see [Optical drive on page 36](#))
 - d. Switch cover (see [Switch cover on page 38](#))
 - e. Keyboard (see [Keyboard on page 40](#))
 - f. Display assembly (see [Display assembly on page 44](#))
 - g. Base enclosure (see [Base enclosure on page 49](#))
 - h. Fan assembly (see [Fan assembly on page 52](#))
 - i. Heat sink (see [Heat sink on page 53](#))

Remove the processor:

1. Use a flat-bladed screwdriver to turn the processor locking screw **(1)** one-half turn counterclockwise until you hear a click.

- Lift the processor (2) straight up and remove it.



NOTE The gold triangle (3) on the processor should be aligned with the triangle (4) embossed on the processor socket when you install the processor.

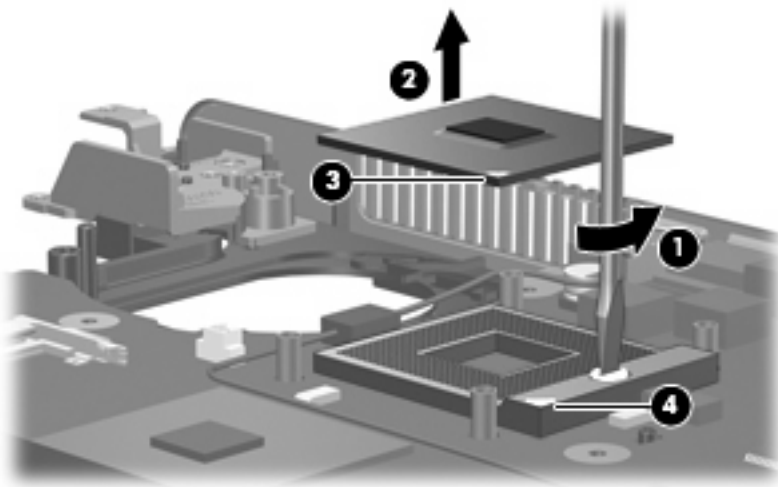

Reverse this procedure to install the processor.

Speaker

Description	Spare part number
Speaker	441627-001

Before removing the speaker, follow these steps:

- Shut down the computer. If you are unsure whether the computer is off or in hibernation, turn the computer on, and then shut it down through the operating system.
- Disconnect all external devices connected to the computer.
- Disconnect the power cord.
- Remove the battery (see [Battery on page 29](#)).
- Remove the following components:
 - Hard drive (see [Hard drive on page 30](#))
 - Memory/Mini PCI card module compartment cover (see [Memory module on page 32](#))
 - Optical drive (see [Optical drive on page 36](#))
 - Switch cover (see [Switch cover on page 38](#))
 - Keyboard (see [Keyboard on page 40](#))
 - Display assembly (see [Display assembly on page 44](#))
 - Base enclosure (see [Base enclosure on page 49](#))

Remove the speaker:

1. Disconnect the speaker cable (1) from the system board.
2. Remove the Phillips PM2.0×9.0 screw (2) that secures the speaker to the top cover.
3. Remove the speaker (3).

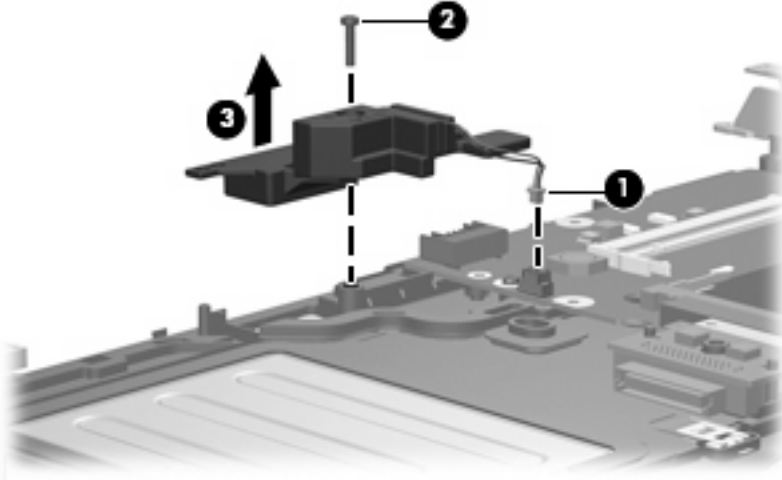

Reverse this procedure to install the speaker.

System board

Description	Spare part number
For use only with full-featured computer models	441635-001
For use only with defeatured computer models with wireless LAN capability	441636-001
For use only with defeatured computer models without wireless LAN capability	441637-001

When replacing the system board, be sure that the following components are removed from the defective system board and installed on the replacement system board:

- Memory module (see [Memory module on page 32](#))
- Mini PCI card module (see [Mini PCI card module on page 34](#))
- RTC battery (see [RTC battery on page 51](#))
- Processor (see [Processor on page 55](#))
- PC Card assembly (see [PC Card assembly on page 61](#))

Before removing the system board, follow these steps:

1. Shut down the computer. If you are unsure whether the computer is off or in hibernation, turn the computer on, and then shut it down through the operating system.
2. Disconnect all external devices connected to the computer.
3. Disconnect the power cord.
4. Remove the battery (see [Battery on page 29](#)).
5. Remove the following components:
 - a. Hard drive (see [Hard drive on page 30](#))
 - b. Memory/Mini PCI card module compartment cover (see [Memory module on page 32](#))
 - c. Optical drive (see [Optical drive on page 36](#))
 - d. Switch cover (see [Switch cover on page 38](#))
 - e. Keyboard (see [Keyboard on page 40](#))
 - f. Display assembly (see [Display assembly on page 44](#))
 - g. Base enclosure (see [Base enclosure on page 49](#))
 - h. Fan assembly (see [Fan assembly on page 52](#))
 - i. Heat sink (see [Heat sink on page 53](#))

Remove the system board:

1. Remove the Phillips PM2.0×3.0 screw that secures the system board to the top cover .

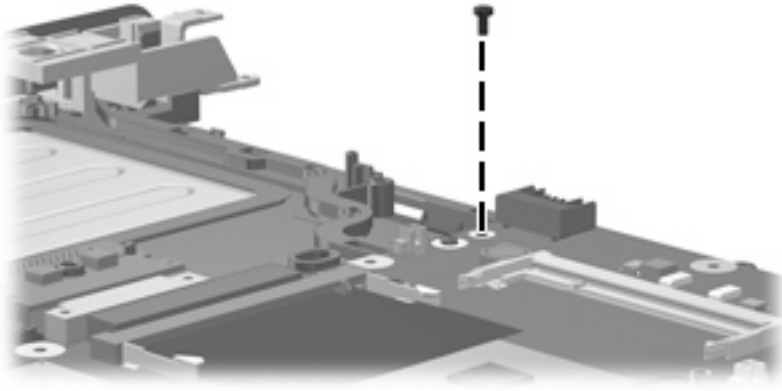

2. Lift the left side of the system board (1) until it rests at an angle.
3. Flex the right side of the top cover (2) until the external monitor connector clears the opening in the top cover.
4. Remove the system board (3) by pulling it away from the top cover at an angle until it clears the top cover

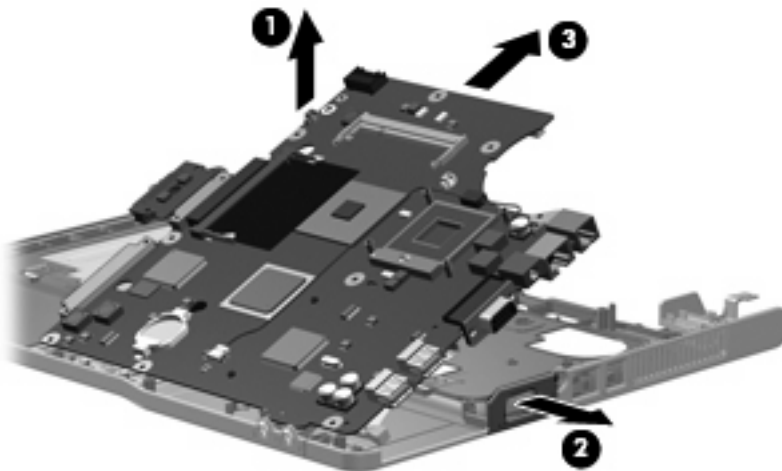

5. If it is necessary to replace the optical drive connector board, pull the board away from the system board until it disconnects from the system board.

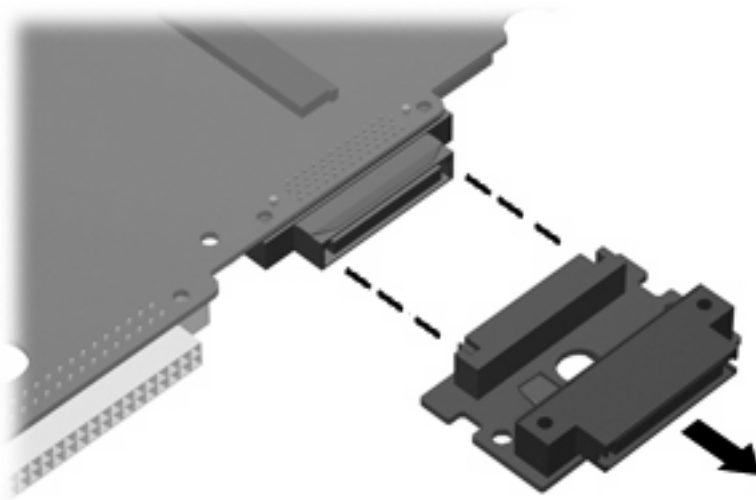

NOTE The optical drive connector board is available using spare part number 441631-001.

Reverse this procedure to install the system board.

PC Card assembly

Description	Spare part number
PC Card assembly	438551-001
PC Card slot bezel	438527-001

Before removing the PC Card assembly, follow these steps:

1. Shut down the computer. If you are unsure whether the computer is off or in hibernation, turn the computer on, and then shut it down through the operating system.
2. Disconnect all external devices connected to the computer.
3. Disconnect the power cord.
4. Remove the battery (see [Battery on page 29](#)).
5. Remove the following components:
 - a. Hard drive (see [Hard drive on page 30](#))
 - b. Memory/Mini PCI card module compartment cover (see [Memory module on page 32](#))
 - c. Optical drive (see [Optical drive on page 36](#))
 - d. Switch cover (see [Switch cover on page 38](#))
 - e. Keyboard (see [Keyboard on page 40](#))
 - f. Display assembly (see [Display assembly on page 44](#))
 - g. Base enclosure (see [Base enclosure on page 49](#))
 - h. Fan assembly (see [Fan assembly on page 52](#))
 - i. Heat sink (see [Heat sink on page 53](#))
 - j. System board (see [System board on page 58](#))

Remove the PC Card assembly:

1. Position the system board with the PC Card eject button toward you.

2. Remove the two Phillips PM2.0×3.0 screws that secure the PC Card assembly to the system board.

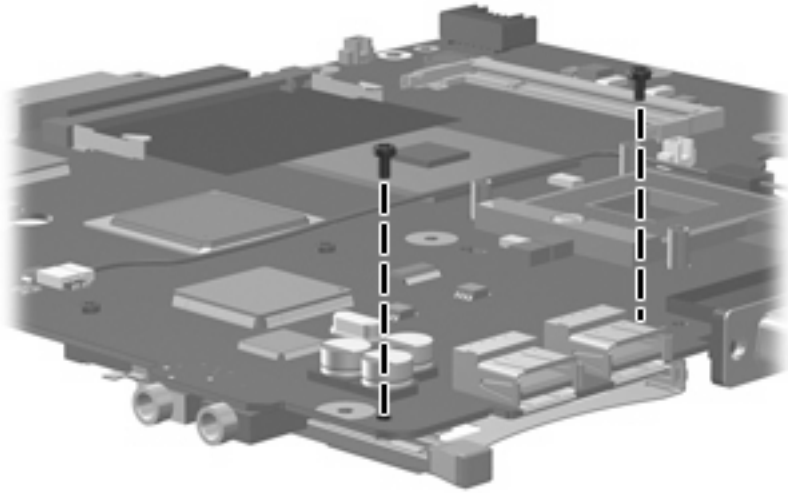

3. Turn the system board top-side up, with the PC Card eject button toward you.
4. Disengage the slots on the PC Card assembly from the tabs (1) on the PC Card connector.
5. Remove the PC Card assembly (2) from the system board.

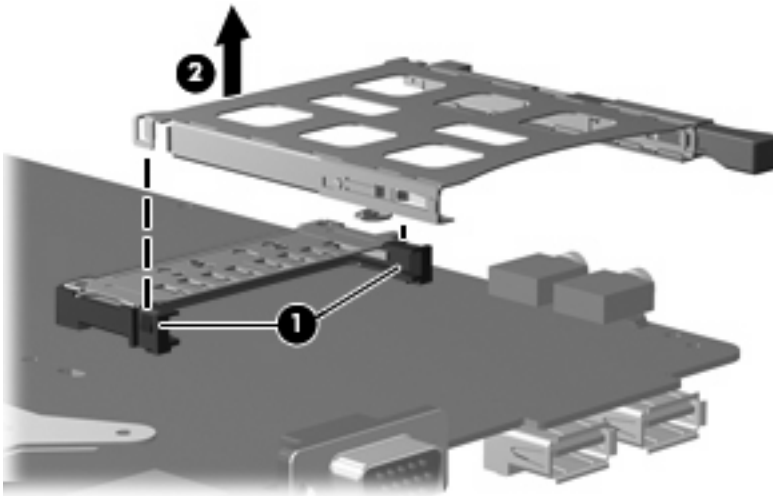

Reverse this procedure to install the PC Card assembly.

TouchPad cable

Description	Spare part number
TouchPad cable	441638-001

Before removing the TouchPad cable, follow these steps:

1. Shut down the computer. If you are unsure whether the computer is off or in hibernation, turn the computer on, and then shut it down through the operating system.
2. Disconnect all external devices connected to the computer.
3. Disconnect the power cord.
4. Remove the battery (see [Battery on page 29](#)).
5. Remove the following components:
 - a. Hard drive (see [Hard drive on page 30](#))
 - b. Memory/Mini PCI card module compartment cover (see [Memory module on page 32](#))
 - c. Optical drive (see [Optical drive on page 36](#))
 - d. Switch cover (see [Switch cover on page 38](#))
 - e. Keyboard (see [Keyboard on page 40](#))
 - f. Display assembly (see [Display assembly on page 44](#))
 - g. Base enclosure (see [Base enclosure on page 49](#))
 - h. Fan assembly (see [Fan assembly on page 52](#))
 - i. Heat sink (see [Heat sink on page 53](#))
 - j. System board (see [System board on page 58](#))

Remove the TouchPad cable:

1. Position the top cover with the front toward you.

2. Release the ZIF connector (1) to which the TouchPad cable is connected and disconnect the TouchPad cable (2) from the TouchPad board.

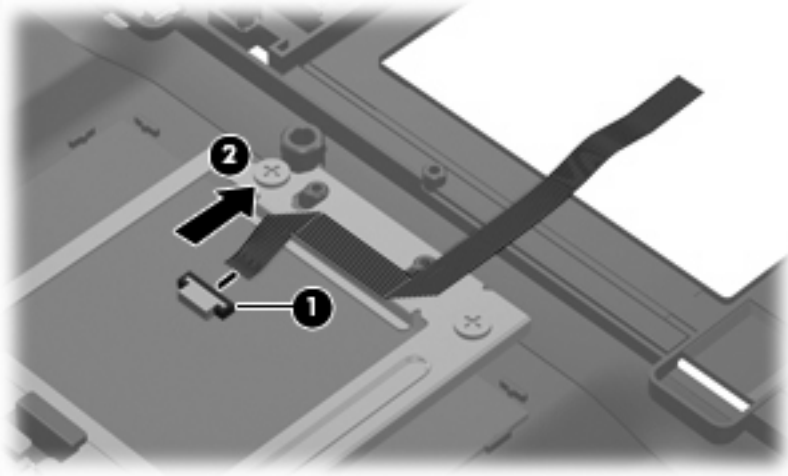

Reverse this procedure to install the TouchPad cable.

6 Computer Setup



WARNING! Only authorized technicians trained by HP should repair this equipment. All troubleshooting and repair procedures are detailed to allow repair at only the subassembly or module level. Because of the complexity of the individual boards and subassemblies, do not attempt to make repairs at the component level or modifications to any printed wiring board. Improper repairs can create a safety hazard. Any indication of component replacement or printed wiring board modification may void any warranty or exchange allowances.

Computer Setup access

Computer Setup is a preinstalled, ROM-based utility that can be used even when the operating system is not working or will not load.



NOTE Some of the Computer Setup menu items listed in this section may not be supported by your computer.

NOTE Pointing devices are not supported in Computer Setup. You must use the keyboard to navigate and make selections.

NOTE An external keyboard connected by USB can be used with Computer Setup only if USB legacy support is enabled.

The information and settings in Computer Setup are accessed from the File, Security, Diagnostics, and System Configuration menus.

To access Computer Setup:

1. Open Computer Setup by turning on or restarting the computer, and then pressing **f10** while the “F10 = ROM Based Setup” message is displayed in the lower-left corner of the screen.

In Computer Setup, the following shortcuts are available:

- To change the language, press **f2**.
 - To view navigation information, press **f1**.
 - To close open dialog boxes and return to the main Computer Setup screen press **esc**.
2. Select the **Files**, **Security**, **Diagnostics**, or **System Configuration** menu.
 3. To exit Computer Setup, choose one of the following methods:
 - To exit Computer Setup without saving your preferences, use the arrow keys to select **File > Ignore Changes and Exit**. Then follow the instructions on the screen.
 - To save your preferences and exit Computer Setup, use the arrow keys to select **File > Save Changes and Exit**. Then follow the instructions on the screen.

Your preferences go into effect when the computer restarts.

Computer Setup defaults

To return all settings in Computer Setup to the values that were set at the factory:

1. Open Computer Setup by turning on or restarting the computer, and then pressing **f10** while the "F10 = ROM Based Setup" message is displayed in the lower-left corner of the screen.

In Computer Setup, the following shortcuts are available:

- To change the language, press **f2**.
 - To view navigation information, press **f1**.
 - To close open dialog boxes and return to the main Computer Setup screen, press **esc**.
2. Use the arrow keys to select **File > Restore defaults**, and then press **enter**.
 3. When the confirmation dialog box opens, press **f10**.
 4. Select the **Restore defaults** check box, and then press **enter**.
 5. To confirm the restoration, press **f10**.
 6. To save your preferences and exit Computer Setup, use the arrow keys to select **File > Save Changes and Exit**. Then follow the instructions on the screen.

Your preferences go into effect when the computer restarts.



NOTE Your password and security settings are not changed when you restore the factory default settings.

Computer Setup menus

The menu tables in this section provide an overview of Computer Setup options.





NOTE Some of the Computer Setup menu items listed in this chapter may not be supported by your computer.

File Menu

Select	To Do This
System information	<ul style="list-style-type: none">View identification information for the computer and the batteries in the system.View specification information for the processor, cache and memory size, system ROM, video revision, and keyboard controller version.
Restore defaults	Replace the configuration settings in Computer Setup with factory settings. (Password and security settings are not changed when you restore the factory default settings.)
Ignore changes and exit	Cancel changes entered during the current session. Then exit and restart the computer.
Save changes and exit	Save changes entered during the current session. Then exit and restart the computer. Your changes go into effect when the computer restarts.

Security menu

Select	To Do This
Setup password	Enter, change, or delete a setup password.
Power-On password	Enter, change, or delete a power-on password.
Password options	<ul style="list-style-type: none">Enable/disable stringent security.Enable/disable password requirement on computer restart.
DriveLock passwords	<ul style="list-style-type: none">Enable/disable DriveLock on any computer hard drive.Change a DriveLock user or master password.
	 NOTE DriveLock settings are accessible only when you enter Computer Setup by turning on (not restarting) the computer.
Smart Card security	Enable/disable support for smart card and Java™ Card power-on authentication.
	 NOTE Power-on authentication for smart cards is supported only on computers with optional smart card readers.
TPM Embedded Security	Enable/disable support for TPM (Trusted Platform Module) Embedded Security, which protects the computer from unauthorized access to owner functions in Embedded Security for ProtectTools. For more information, refer to the ProtectTools Security Manager Reference Guide located in Help and Support, or refer to Credential Manager for ProtectTools online Help.

Select	To Do This
System IDs	Enter user-defined computer asset and ownership tag.
Disk Sanitizer	<p>Run Disk Sanitizer to destroy all existing data on the primary hard drive. The following options are available:</p> <ul style="list-style-type: none"> • Fast: Runs the Disk Sanitizer erase cycle once. • Optimum: Runs the Disk Sanitizer erase cycle 3 times. • Custom: Allows you to select the desired number of Disk Sanitizer erase cycles from a list. <p> CAUTION If you run Disk Sanitizer, the data on the primary hard drive is destroyed permanently.</p>

Diagnostics menu

Select	To Do This
Memory Check	Run a comprehensive check on system memory.
Hard Drive Self-Test options	Run a comprehensive self-test on any hard drive in the system.

System Configuration menu

Select	To Do This
Language (or press f2)	Change the Computer Setup language.
Boot options	<ul style="list-style-type: none"> • Set f9, f10, and f12 delay when starting up. • Enable/disable CD-ROM boot. • Enable/disable Floppy boot. • Enable/disable internal network adapter boot and set the boot mode (PXE or RPL). • Enable/disable MultiBoot, which sets a boot order that can include most boot devices in the system. • Set the boot order.
Device configurations	<ul style="list-style-type: none"> • Swap the functions of the fn key and left ctrl key. • Enable/disable multiple standard pointing devices at startup. (To set the computer to support only a single, usually nonstandard, pointing device at startup, select Disable.) • Enable/disable USB legacy support. When enabled, USB legacy support allows <ul style="list-style-type: none"> • A USB keyboard, mouse, and hub to work in Computer Setup even when a Windows operating system is not loaded. • The computer to start from bootable USB devices, including a hard drive, diskette drive diskette, or optical drive connected by a USB

Select	To Do This
	<p>port to the computer or to an optional docking device (select models only).</p> <ul style="list-style-type: none"> • Automatic/disable Intel SpeedStep Technology. • Select a parallel port mode: EPP (Enhanced Parallel Port), standard, bidirectional, or ECP (Enhanced Capabilities Port). • Enable/disable BIOS DMA data transfers (select models only) • Enable/disable the system fan when connected to an AC outlet. • Enable/disable Intel or AMD PSAE Execution Disable. When enabled, the processor can disable some virus code execution, which helps to improve computer security. • Enable/disable LAN Power Save. When enabled, saves power by turning off the LAN when not in use. • Enable/disable SATA Native Support. • Enable/disable Dual Core CPU. • Enable/disable Secondary Battery Fast Charge.
Built-in Device Options	<ul style="list-style-type: none"> • Enable/disable embedded WWAN Device Radio. • Enable/disable embedded WLAN Device Radio • Enable/disable embedded Bluetooth® Device Radio. • Enable/disable LAN/WLAN Switching. When enabled, switches to a WLAN when a LAN is either unavailable or disconnected. • Enable/disable Wake on LAN from Off. • Enable/disable the ambient light sensor.
Port Options	<ul style="list-style-type: none"> • Enable/disable the serial port. • Enable/disable the parallel port. • Enable/disable the flash media reader. • Enable/disable the USB port. <p> CAUTION Disabling the USB port also disables MultiBay devices and ExpressCard devices on the advanced port replicator.</p> <ul style="list-style-type: none"> • Enable/disable the 1394 port. • Enable/disable the cardbus slot. • Enable/disable the ExpressCard slot. • Enable/disable the infrared port.

7 Specifications

Computer specifications

	Metric	U.S.
Dimensions		
Height (front to back)	3.19 to 3.59 cm	1.26 to 1.41 in
Width	35.79 cm	14.09 in
Depth	25.70 cm	10.12 in
Weight (with optical drive, hard drive, and battery)	2.67 kg	5.88 lbs
Input power		
Operating voltage	18.5 V dc @ 3.5 A – 65 W	
Operating current	3.5 A	
Temperature		
Operating (not writing to optical disc)	0°C to 35°C	32°F to 95°F
Operating (writing to optical disc)	5°C to 35°C	41°F to 95°F
Nonoperating	-20°C to 60°C	-4°F to 140°F
Relative humidity		
Operating	10% to 90%	
Nonoperating	5% to 95%	
Maximum altitude (unpressurized)		
Operating (14.7 to 10.1 psia)	-15 m to 3,048 m	50 ft to 10,000 ft
Nonoperating (14.7 to 4.4 psia)	-15 m to 12,192 m	-50 ft to 40,000 ft
Shock		
Operating	125 g, 2 ms, half-sine	
Nonoperating	200 g, 2 ms, half-sine	
Random vibration		
Operating	0.75 g zero-to-peak, 10 Hz to 500 Hz, 0.25 oct/min sweep rate	

	Metric	U.S.
Nonoperating	1.50 g zero-to-peak, 10 Hz to 500 Hz, 0.5 oct/min sweep rate	
 NOTE	Applicable product safety standards specify thermal limits for plastic surfaces. The computer operates well within this range of temperatures.	

15.4-inch, WXGA display specifications

	Metric	U.S.
Dimensions		
Height	20.7 cm	8.15 in
Width	33.1 cm	13.03 in
Diagonal	39.1 cm	15.39 in
Number of colors	Up to 16.8 million	
Contrast ratio	200:1 (typical)	
Brightness	160 nits (typical)	
Pixel resolution		
Pitch	0.259 × 0.259 mm	
Format	1280 × 800	
Configuration	RGB vertical stripe	
Backlight	Edge lit	
Refresh rate	60 Hz	
PPI	107	
Viewing angle	+/-65° horizontal, +/-50° vertical (typical)	

Hard drive specifications

	60-GB*	40-GB*
Dimensions		
Height	9.5 mm	9.5 mm
Width	70 mm	70 mm
Weight	101 g	101 g
Interface type		
	ATA-7	ATA-7
Transfer rate		
Synchronous (maximum)	100 MB/sec	100 MB/sec
Security	ATA security	ATA security
Seek times (typical read, including setting)		
Single track	3 ms	3 ms
Average	13 ms	13 ms
Maximum	24 ms	24 ms
Logical blocks		
	117,210,240	78,140,160
Disc rotational speed		
	5400-rpm	4200-rpm
Operating temperature		
	5°C to 55°C (41°F to 131°F)	

*1 GB = 1 billion bytes when referring to hard drive storage capacity. Actual accessible capacity is less.

†Actual drive specifications may differ slightly.



NOTE Certain restrictions and exclusions apply. Contact technical support for details.

Primary 4-cell, Li-ion battery specifications

	Metric	U.S.
Dimensions		
Height	2.00 cm	0.79 in
Width	26.80 cm	3.70 in
Depth	5.30 cm	5.28 in
Weight	0.34 kg	0.75 lb
Energy		
Voltage	14.4 V	
Amp-hour capacity	2.2 Ah	
Watt-hour capacity	32 Wh	
Temperature		
Operating	5°C to 45°C	41°F to 113°F
Nonoperating	0°C to 60°C	32°F to 140°F

DVD±RW and CD-RW Super Multi Double-Layer Combo Drive specifications

Applicable disc	Read:	Write:
	CD-DA, CD+(E)G, CD-MIDI, CD-TEXT, CD-ROM, CD-ROM XA, MIXED MODE CD, CD-I, CD-I Bridge (Photo-CD, Video CD), Multisession CD (Photo-CD, CD-EXTRA, Portfolio, CD-R, CD-RW), CD-R, CD-RW, DVD-ROM (DVD-5, DVD-9, DVD-10, DVD-18), DVD-R, DVD-RW, DVD+R, DVD+RW, DVD-RAM	CD-R and CD-RW DVD+R, DVD+RW, DVD-R, DVD-RW, DVD-RAM
Center hole diameter	1.5 cm (0.59 in)	
Disc diameter		
Standard disc	12 cm (4.72 in)	
Mini disc	8 cm (3.15 in)	
Disc thickness	1.2 mm (0.047 in)	
Track pitch	0.74 μm	
Access time	CD	DVD
Random	< 175 ms	< 230 ms
Full stroke	< 285 ms	< 335 ms
Audio output level	Audio-out, 0.7 Vrms	
Cache buffer	2 MB	
Data transfer rate		
24X CD-ROM	3,600 KB/sec	
8X DVD	10,800 KB/sec	
24X CD-R	3,600 KB/sec	
16X CD-RW	2,400 KB/sec	
8X DVD+R	10,800 KB/sec	
4X DVD+RW	5,400 KB/sec	
8X DVD-R	10,800 KB/sec	
4X DVD-RW	5,400 KB/sec	
2.4X DVD+R(9)	2,700 KB/sec	
5X DVD-RAM	6,750 KB/sec	
Transfer mode	Multiword DMA Mode	
Startup time	< 15 seconds	
Stop time	< 6 seconds	

DVD±RW/R and CD-RW Double-Layer Combo Drive specifications

Applicable disc	Read:	Write:
	CD-DA, CD+(E)G, CD-MIDI, CD-TEXT, CD-ROM, CD-ROM XA, MIXED MODE CD, CD-I, CD-I Bridge (Photo-CD, Video CD), Multisession CD (Photo-CD, CD-EXTRA, Portfolio, CD-R, CD-RW), CD-R, CD-RW, DVD-ROM (DVD-5, DVD-9, DVD-10, DVD-18), DVD-R, DVD-RW, DVD+R, DVD+RW, DVD-RAM	CD-R and CD-RW
Center hole diameter	1.5 cm (0.59 in)	
Disc diameter		
Standard disc	12 cm (4.72 in)	
Mini disc	8 cm (3.15 in)	
Disc thickness	1.2 mm (0.047 in)	
Track pitch	0.74 μm	
Access time	CD	DVD
Random	< 110 ms	< 130 ms
Full stroke	< 210 ms	< 225 ms
Audio output level	Line-out, 0.7 Vrms	
Cache buffer	2 MB	
Data transfer rate	24X CD-ROM 3,600 KB/s 8X DVD 10,800 KB/s 24X CD-R 3,600 KB/s 24X CD-RW 3,600 KB/s	
24X CD-ROM	3,600 KB/sec	
8X DVD	10,800 KB/sec	
24X CD-R	3,600 KB/sec	
24X CD-RW	3,600 KB/sec	
Transfer mode	Multiword DMA mode 2	
Startup time	< 15 seconds	
Stop time	< 6 seconds	

System DMA specifications

Hardware DMA	System function
DMA0	Not applicable
DMA1*	Not applicable
DMA2*	Not applicable
DMA3	Not applicable
DMA4	Direct memory access controller
DMA5*	Available for PC Card
DMA6	Not assigned
DMA7	Not assigned

*PC Card controller can use DMA 1, 2, or 5.

System interrupt specifications

Hardware IRQ	System function
IRQ0	System timer
IRQ1	Standard 101-/102-Key or Microsoft® Natural Keyboard
IRQ2	Cascaded
IRQ3	Intel 82801DB/DBM USB2 Enhanced Host Controller—24CD
IRQ4	COM1
IRQ5*	Conexant AC—Link Audio Intel 82801DB/DBM SMBus Controller—24C3 Data Fax Modem with SmartCP
IRQ6	Diskette drive
IRQ7*	Parallel port
IRQ8	System CMOS/real-time clock
IRQ9*	Microsoft ACPI-compliant system
IRQ10*	Intel USB UHCI controller—24C2 Intel 82852/82855 GM/GME Graphic Controller Realtek RTL8139 Family PCI Fast Ethernet Controller
IRQ11	Intel USB EHCI controller—24CD Intel USB UHCI controller—24C4 Intel USB UHCI controller—24C7 Intel Pro/Wireless 2200BG TI OHCI 1394 host controller TI PCI1410 CardBus controller
IRQ12	Synaptics PS/2 TouchPad
IRQ13	Numeric data processor
IRQ14	Primary IDE channel
IRQ15	Secondary IDE channel

*Default configuration; audio possible configurations are IRQ5, IRQ7, IRQ9, IRQ10, or none.

 **NOTE** PC Cards may assert IRQ3, IRQ4, IRQ5, IRQ7, IRQ9, IRQ10, IRQ11, or IRQ15. Either the infrared or the serial port may assert IRQ3 or IRQ4.

System I/O address specifications

I/O address (hex)	System function (shipping configuration)
000 - 00F	DMA controller no. 1
010 - 01F	Unused
020 - 021	Interrupt controller no. 1
022 - 024	Opti chipset configuration registers
025 - 03F	Unused
02E - 02F	87334 "Super I/O" configuration for CPU
040 - 05F	Counter/timer registers
044 - 05F	Unused
060	Keyboard controller
061	Port B
062 - 063	Unused
064	Keyboard controller
065 - 06F	Unused
070 - 071	NMI enable/RTC
072 - 07F	Unused
080 - 08F	DMA page registers
090 - 091	Unused
092	Port A
093 - 09F	Unused
0A0 - 0A1	Interrupt controller no. 2
I/O Address (hex)	System Function (shipping configuration)
0A2 - 0BF	Unused
0C0 - 0DF	DMA controller no. 2
0E0 - 0EF	Unused
0F0 - 0F1	Coprocessor busy clear/reset
0F2 - 0FF	Unused
100 - 16F	Unused
170 - 177	Secondary fixed disk controller
178 - 1EF	Unused
1F0 - 1F7	Primary fixed disk controller
1F8 - 200	Unused
201	JoyStick (decoded in ESS1688)
202 - 21F	Unused

I/O address (hex)	System function (shipping configuration)
220 - 22F	Entertainment audio
230 - 26D	Unused
26E - 26	Unused
278 - 27F	Unused
280 - 2AB	Unused
2A0 - 2A7	Unused
2A8 - 2E7	Unused
2E8 - 2EF	Reserved serial port
2F0 - 2F7	Unused
2F8 - 2FF	Infrared port
300 - 31F	Unused
320 - 36F	Unused
370 - 377	Secondary diskette drive controller
378 - 37F	Parallel port (LPT1/default)
380 - 387	Unused
388 - 38B	FM synthesizer—OPL3
38C - 3AF	Unused
3B0 - 3BB	VGA
3BC - 3BF	Reserved (parallel port/no EPP support)
3C0 - 3DF	VGA
3E0 - 3E1	PC Card controller in CPU
3E2 - 3E3	Unused
3E8 - 3EF	Internal modem
3F0 - 3F7	“A” diskette controller
3F8 - 3FF	Serial port (COM1/default)
CF8 - CFB	PCI configuration index register (PCIDIVO-1)
CFC - CFF	PCI configuration data register (PCIDIVO-1)

System memory map specifications

Size	Memory address	System function
640 KB	00000000-0009FFFF	Base memory
128 KB	000A0000-000BFFFF	Video memory
48 KB	000C0000-000CBFFF	Video BIOS
160 KB	000C8000-000E7FFF	Unused
64 KB	000E8000-000FFFFFF	System BIOS
15 MB	00100000-00FFFFFF	Extended memory
58 MB	04800000-07FFFFFF	Super extended memory
58 MB	04800000-07FFFFFF	Unused
2 MB	08000000-080FFFFFF	Video memory (direct access)
4 GB	08200000-FFFEFFFF	Unused
64 KB	FFFF0000-FFFFFFFF	System BIOS

8 Screw listing

This section provides specification and reference information for the screws and screw locks used in the computer. All screws and screw locks listed in this section are available in the Screw Kit, spare part number 441629-001, and the Display Screw Kit, spare part number 440714-001.

Phillips PM2.5×6.0 captive screw

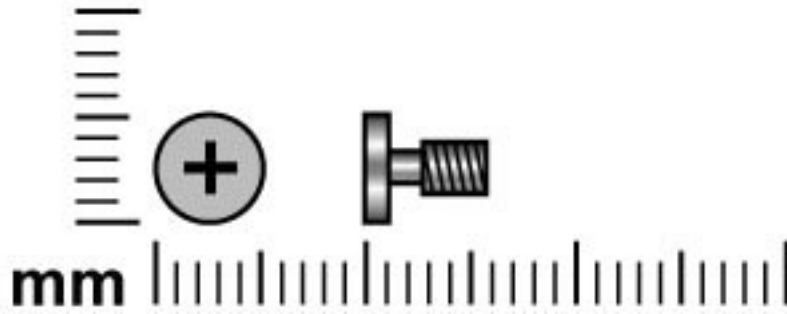

Color	Quantity	Length	Thread	Head width
Black	3	6.0 mm	2.5 mm	5.0 mm

Where used:

(1) Two screws that secure the hard drive cover to the computer (screws are captured on the cover by C-clips; see [Hard drive on page 30](#))

(2) One screw that secures the memory/Mini PCI card module compartment cover to the computer (screw is captured on the cover by a C-clip; see [Memory module on page 32](#))

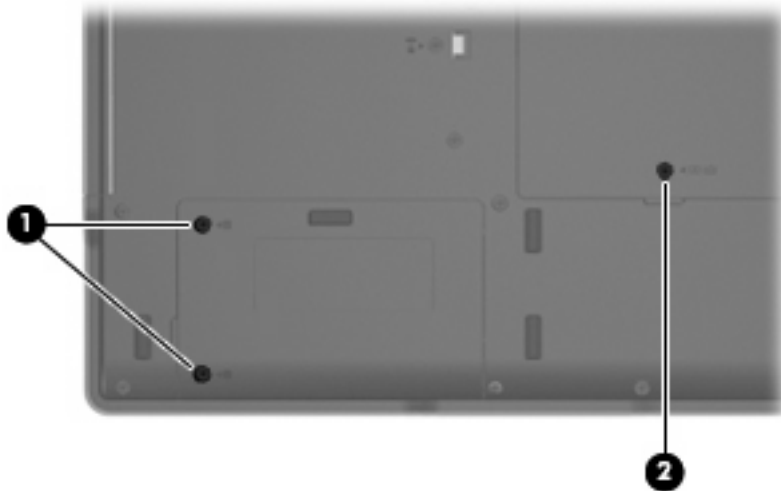

Phillips PM3.0×3.0 screw

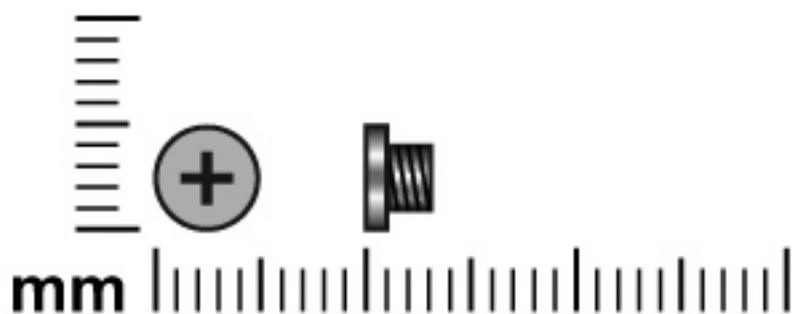

Color	Quantity	Length	Thread	Head width
Silver	4	3.0 mm	3.0 mm	5.0 mm

Where used: 4 screws that secure the hard drive bracket to the hard drive (see [Hard drive on page 30](#))

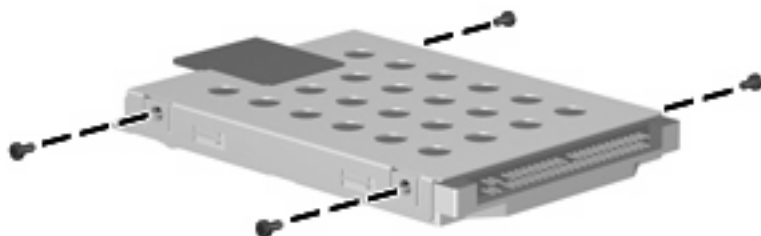

Phillips PM2.0×9.0 screw

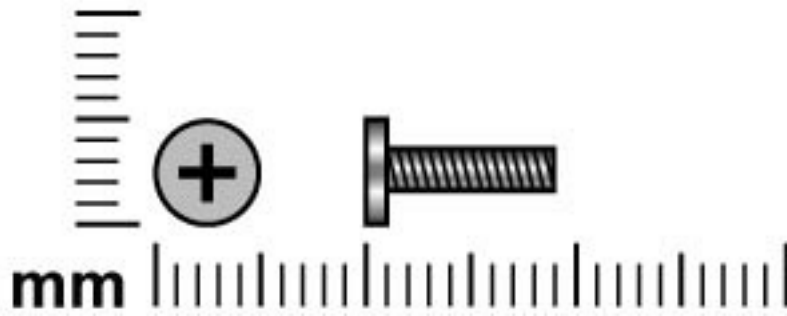

Color	Quantity	Length	Thread	Head width
Black	26	9.0 mm	2.0 mm	5.0 mm

Where used:

- (1) One screw that secures the optical drive to the computer (see [Optical drive on page 36](#))
- (2) Two screws that secure the keyboard to the computer (see [Keyboard on page 40](#))

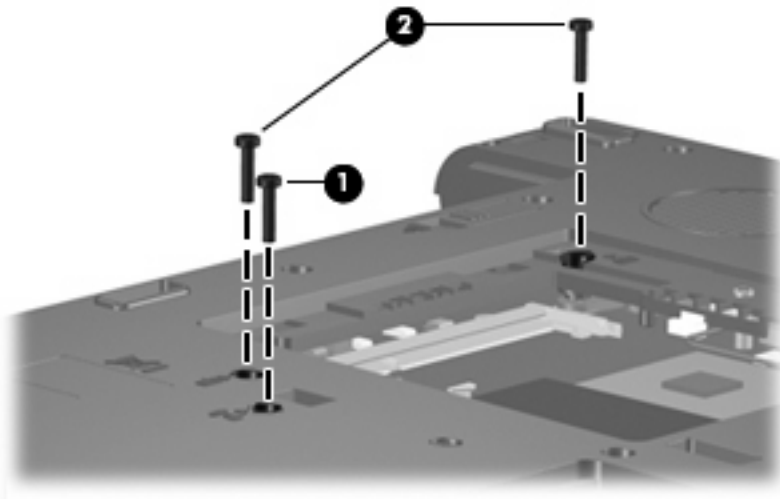

Where used: 7 screws that secure the switch cover to the computer (see [Switch cover on page 38](#))

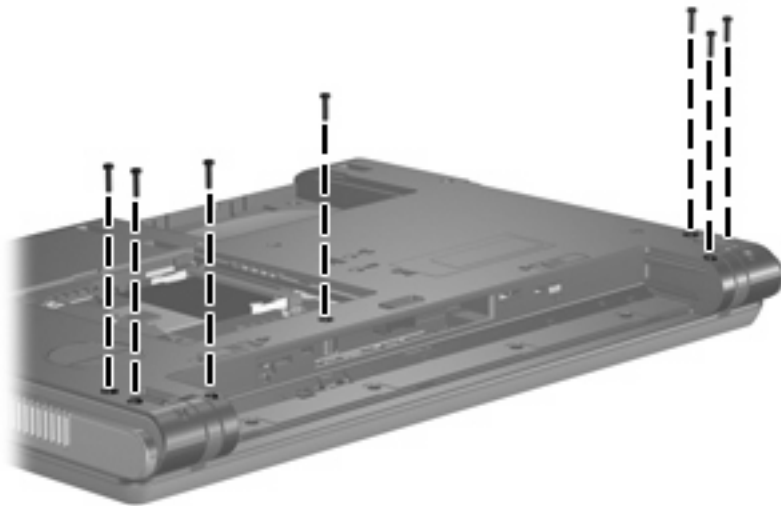

Where used: 2 screws that secure the display assembly to the computer (see [Display assembly on page 44](#))

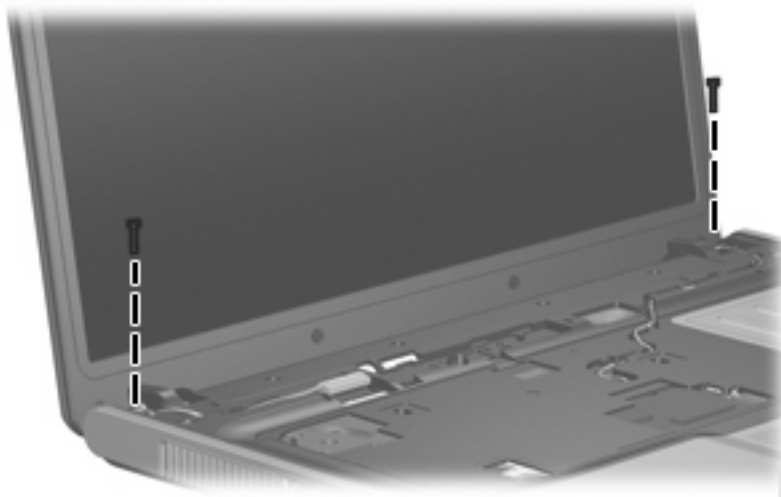

Where used: 12 screws that secure the base enclosure to the computer (see [Base enclosure on page 49](#))

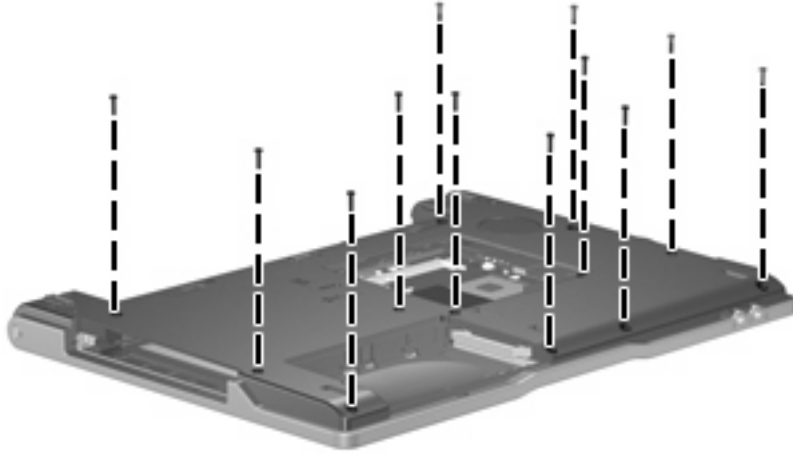

Where used:

- (1) One screw that secures the fan assembly to the computer (see [Fan assembly on page 52](#))
- (2) One screw that secures the speaker to the computer (see [Speaker on page 56](#))

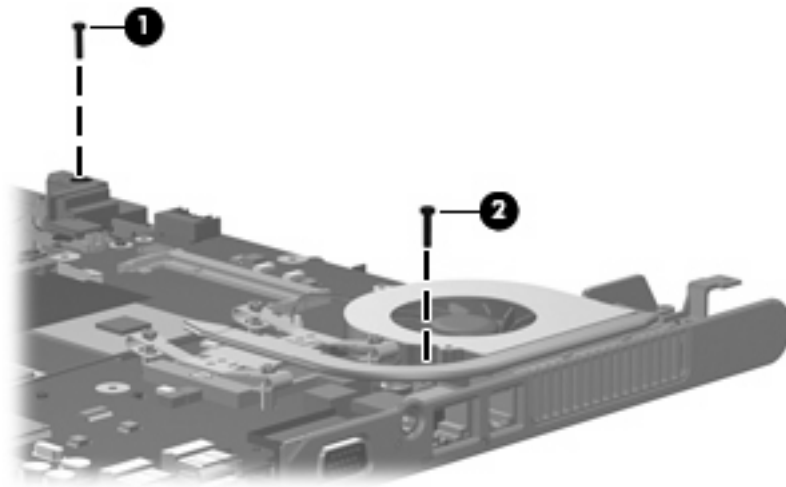

Phillips PM2.0×3.0 screw

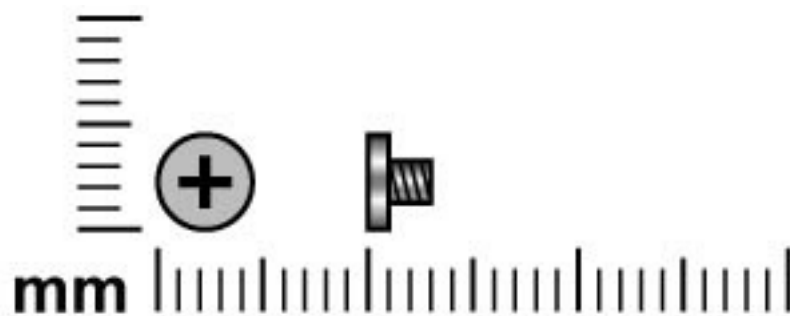

Color	Quantity	Length	Thread	Head width
Silver	16	3.0 mm	2.0 mm	4.5 mm

Where used: 2 screws that secure the optical drive bracket to the optical drive (see [Optical drive on page 36](#))

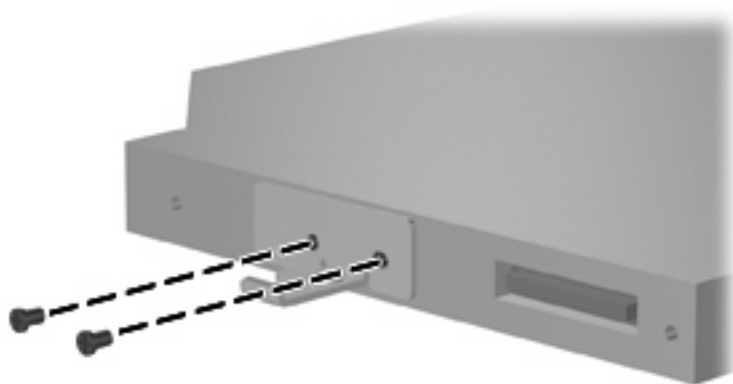

Where used: One screw that secures the button board to the computer (see [Button board on page 43](#))

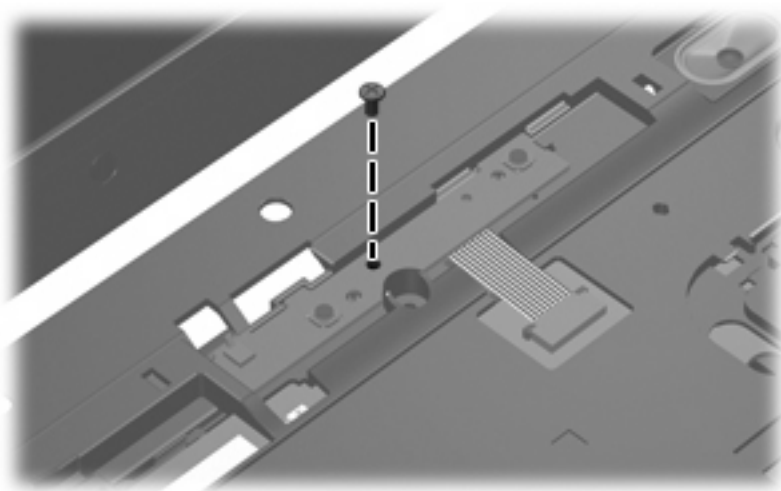

Where used: 4 screws that secure each display hinge to the display panel (see [Display assembly on page 44](#))

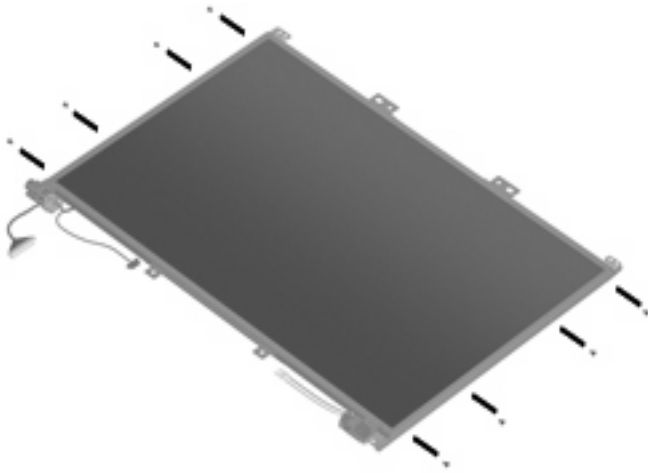

Where used: 2 screws that secure the base enclosure to the top cover (see [Base enclosure on page 49](#))

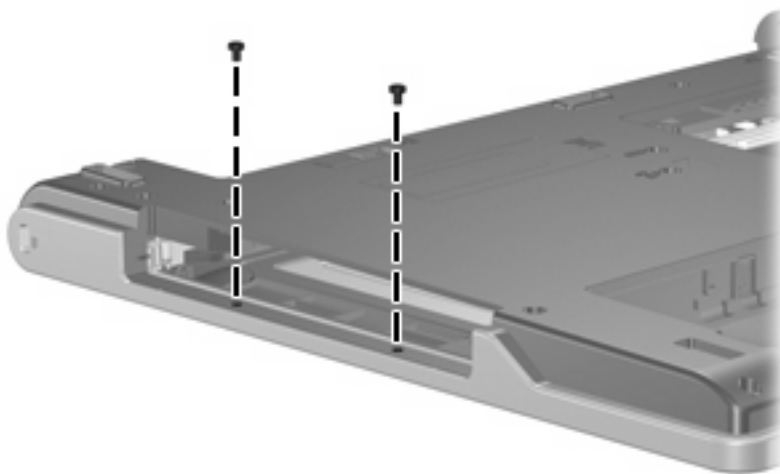

Where used: One screw that secures the system board to the base enclosure (see [System board on page 58](#))

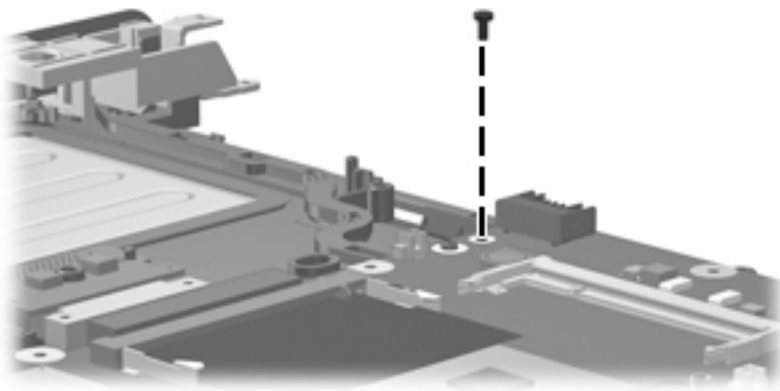

Where used: 2 screws that secure the PC Card assembly to the system board (see [PC Card assembly on page 61](#))

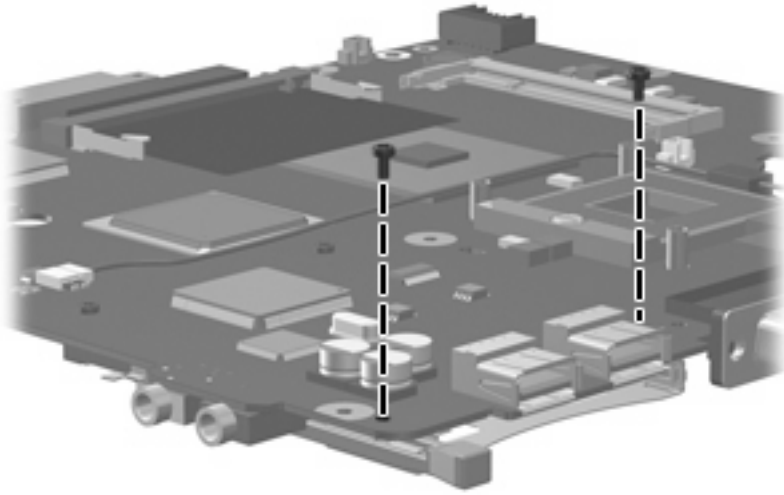

Phillips PM2.0×2.0 screw

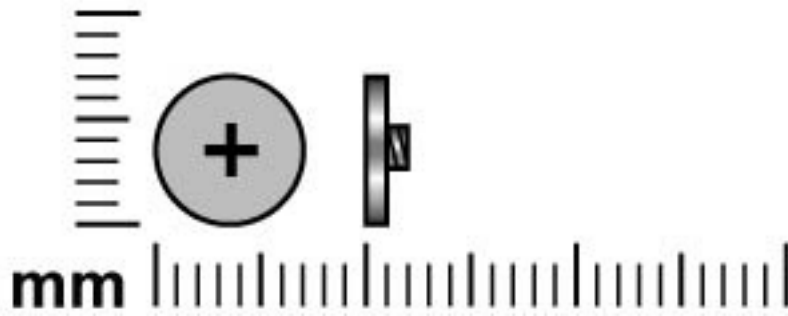

Color	Quantity	Length	Thread	Head width
Black	4	2.0 mm	2.0 mm	7.0 mm

Where used: 4 screws that secure the switch cover to the computer (see [Switch cover on page 38](#))

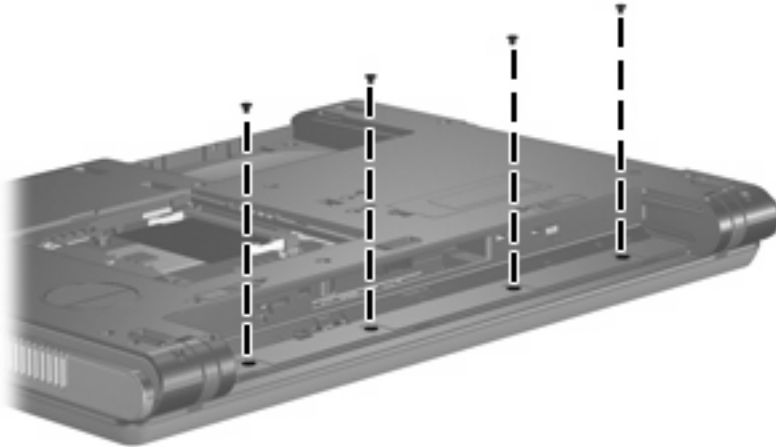

Phillips PM2.0×7.0 screw

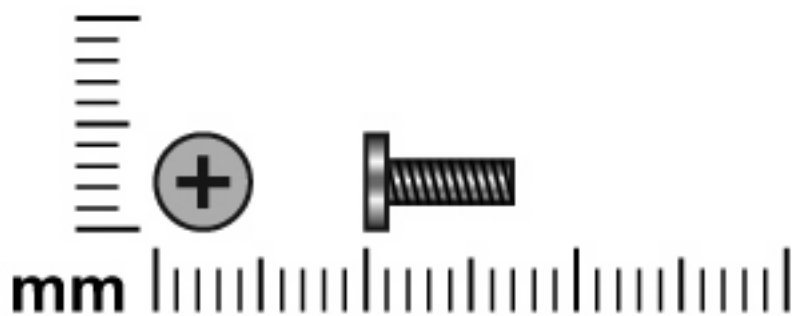

Color	Quantity	Length	Thread	Head width
Black	2	7.0 mm	2.0 mm	5.0 mm

Where used: 2 screws that secure the display assembly to the computer (see [Display assembly on page 44](#))

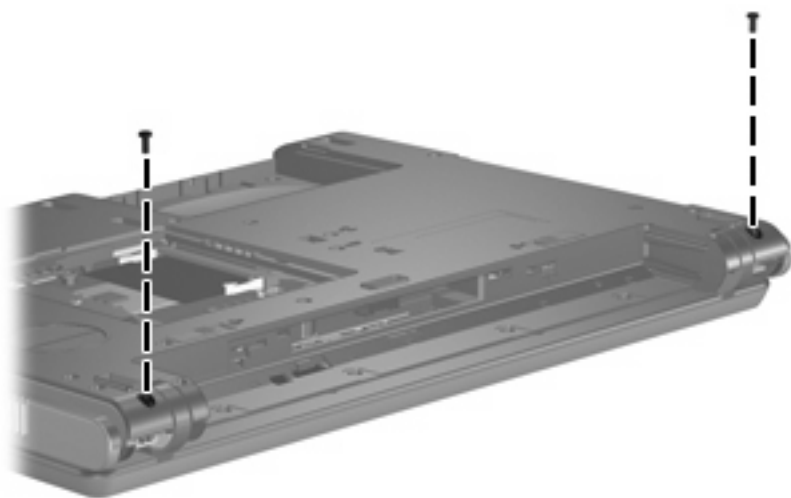

Phillips PM2.5×6.0 screw

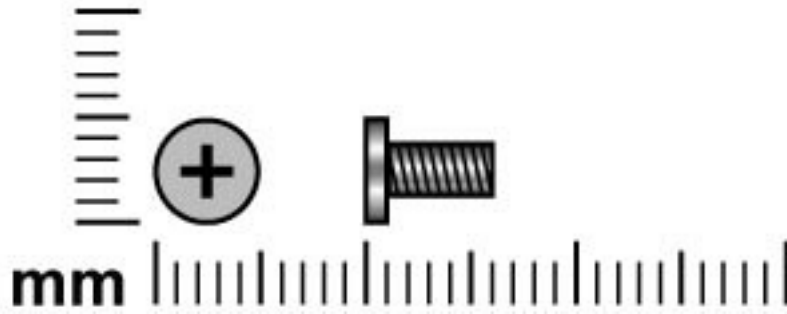

Color	Quantity	Length	Thread	Head width
Silver	16	6.0 mm	2.5 mm	5.0 mm

Where used: 8 screws that secure the display bezel to the display assembly (see [Display assembly on page 44](#))

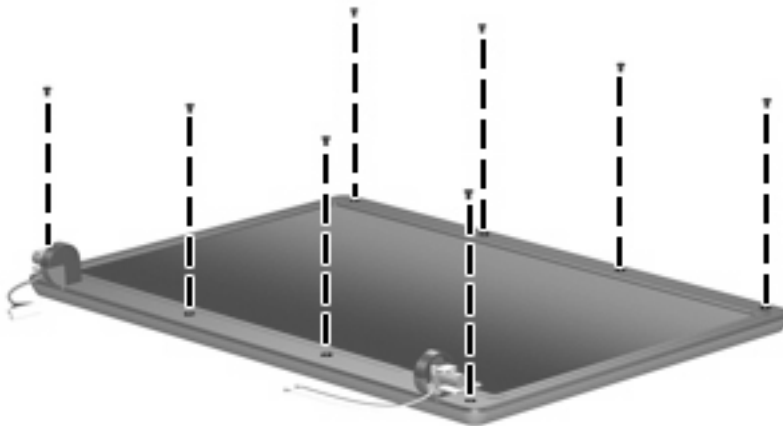

Where used: 4 screws that secure the display panel to the display enclosure (see [Display assembly on page 44](#))



Where used: 4 screws that secure the heat sink to the base enclosure (see [Heat sink on page 53](#))

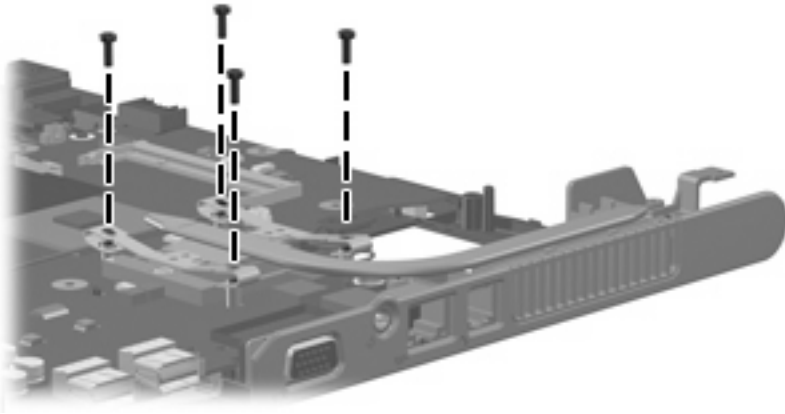

Phillips PM2.5×4.0 screw

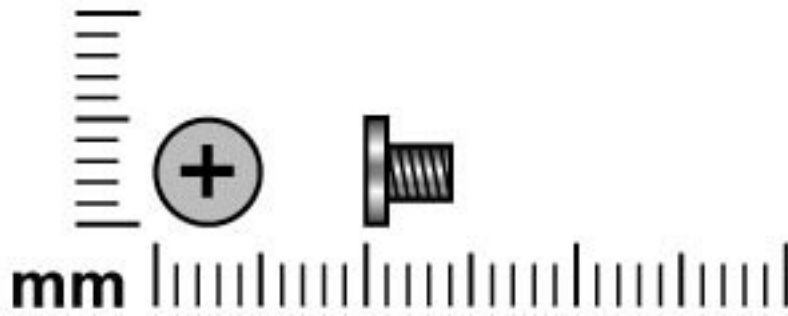

Color	Quantity	Length	Thread	Head width
Silver	2	4.0 mm	2.5 mm	5.0 mm

Where used: 2 screws that secure the wireless antenna transceivers to the display enclosure (see [Display assembly on page 44](#))

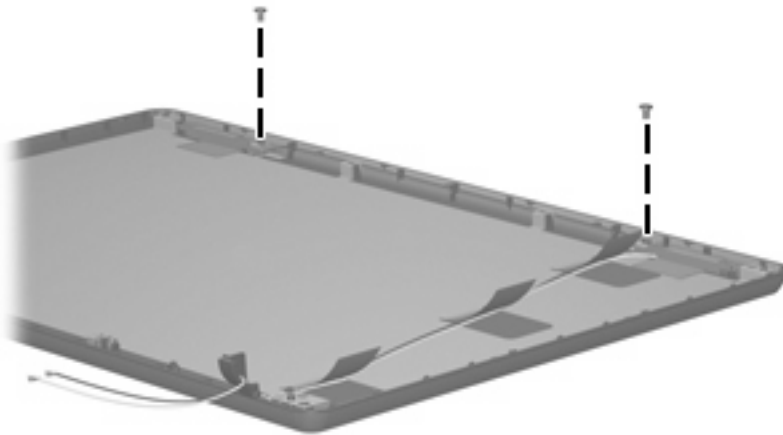

9 Backup and recovery

Backup

HP Backup and Recovery Manager provides several ways to back up the system and to recover optimal system functionality.



NOTE HP installed drivers, utilities, and applications can be copied to a CD or to a DVD using HP Backup and Recovery Manager.

NOTE Formatted DVD±RW discs and DVD±RW double-layer discs are not compatible with HP Backup and Recovery Manager.

NOTE The computer must be connected to external power before you perform backup and recovery procedures.

Safeguarding your data

To safeguard your documents, store personal files in the My Documents folder and periodically create a backup copy of the folder.

Backing up the system

HP Backup and Recovery Manager can perform the following tasks:

- Backing up specific files and folders
- Backing up the entire hard drive
- Backing up modifications since your last backup, using HP system restore points
- Scheduling backups

Backing up specific files or folders

You can back up specific files or folders to the hard drive, to an optional external hard drive, or to discs.



NOTE This process will take several minutes, depending on the file size and the speed of the computer.

To back up specific files or folders:

1. Select **Start > All Programs > HP Backup & Recovery > HP Backup and Recovery Manager**.
2. Click **Next**.

3. Click **Back up to protect system settings and important data files**, and then click **Next**.
4. Click **Back up individual files and folders**, and then click **Next**.
5. The Backup Wizard opens.
6. Click **Next**.
7. Click **Backup selected files from most common locations (Recommended)**.

- or -

Click **Advanced Backup (Experienced users)** to access advanced filtering techniques.

8. Click **Next**.
9. Follow the on-screen instructions.



NOTE If you are backing up your information onto a disc, you will be prompted to insert a blank disc into the optical drive.

Backing up the entire hard drive

When you perform a complete backup of the hard drive, you are saving the full factory image, including the Windows operating system, software applications, and all personal files and folders.



NOTE A copy of the entire hard drive image can be stored on another hard drive, on a network drive, or on recovery discs that you create.

NOTE This process may take over an hour, depending on your computer speed and the amount of data being stored.

To back up your entire hard drive:

1. Select **Start > All Programs > HP Backup & Recovery > HP Backup and Recovery Manager**.
2. Click **Next**.
3. Click **Back up to protect system settings and important data files**, and then click **Next**.
4. Click **Back up entire hard drive**, and then click **Next**.
5. The “Back up entire hard disk” page opens.
6. Click **Next**.
7. Select the location for the backup files, and then click **Next**.
8. Select the **Protect data access with password** check box, and type your password in the **Password and Confirm** boxes.



NOTE This step is optional. If you do not want to password-protect your data access, clear the **Protect data access with password** check box.

9. Click **Next**.
10. Follow the on-screen instructions.

Backing up modifications made to the system

When you back up modifications since your last backup, you are creating system recovery points. This allows you to save a snapshot of your hard drive at a specific point in time. You can then recover back to that point if you want to reverse subsequent changes made to your system.



NOTE The first system recovery point, a snapshot of the entire image, is automatically created the first time you perform a backup. Subsequent recovery points make a copy of changes made after that time.

HP recommends creating recovery points at these times:

- Before you add or extensively modify software or hardware
- Periodically, whenever the system is performing optimally



NOTE Recovering to an earlier recovery point does not affect data files or e-mails created since that recovery point.

After you create a recovery point, you are prompted to schedule subsequent recovery points. You can schedule recovery points for a specific time or event in your system.

To create and schedule a system recovery point:

1. Select **Start > All Programs > HP Backup & Recovery > HP Backup and Recovery Manager**.
2. Click **Next**.
3. Click **Back up to protect system settings and important data files**, and then click **Next**.
4. Click **Create or manage Recovery Points**, and then click **Next**.
5. Follow the on-screen instructions.

Scheduling backups

To schedule backups:

1. Select **Start > All Programs > HP Backup & Recovery > HP Backup Scheduler**.
2. Click **Next**.
3. Schedule system recovery points at specific intervals (now, daily, weekly, or monthly) or at specific events, such as at system start or when you dock to an optional docking station (select models only), by clicking one of the available options. Click **Next** to further define the settings.

A summary of your system recovery point settings is displayed.

4. Follow the on-screen instructions.

Recovery

HP Backup and Recovery Manager analyzes the hard drive and creates a dedicated hard drive recovery partition on the hard drive large enough to store a copy of the full factory image. You can choose whether you want to store that copy on the recovery partition, on another drive, or on external recovery discs.



NOTE Before using HP Backup and Recovery Manager, try repairing the system by running Windows System Restore. For more information, select **Start > Help and Support**, and then search for “System Restore.”

HP Backup and Recovery Manager performs these tasks:

- **Creating recovery discs (highly recommended)**—The recovery discs are used to start up your computer and to recover the full factory image (operating system and software) in case of system failure or instability.



NOTE If you do not have a CD or DVD burner, a copy of the entire hard drive image can be stored on another hard drive or on a network drive.

- **Performing a recovery**—You can perform a full system recovery or recover important files from the recovery partition on the hard drive, from another drive, or from recovery discs that you create.

Creating recovery discs (highly recommended)

After setting up the computer for the first time, you can create a set of recovery discs of the full factory image, using Recovery Media Creator in the HP Backup and Recovery Manager. The recovery discs are used to start up (boot) the computer and recover the operating system and software to factory settings in case of system failure or instability.



CAUTION After you create the recovery discs, you can increase the amount of available space on the hard drive by deleting the recovery partition. However, doing this is not recommended. If you delete this partition, you will lose any information that is on the partition.



NOTE Only one set of recovery discs can be created for this computer.

Before creating recovery discs:

- Obtain high-quality CD-R, DVD-R, or DVD+R media, purchased separately.



NOTE Formatted DVD±RW discs and DVD±RW double-layer discs are not compatible with HP Backup and Recovery Manager.

- Number each disc before inserting it into the optical drive of the computer.
- If necessary, you can cancel Recovery Media Creator before you have finished creating the recovery discs. The next time you open Recovery Media Creator, you will be prompted to continue the disc creation process where you left off.

To create a set of recovery discs:

1. Select **Start > All Programs > HP Backup & Recovery > HP Backup and Recovery Manager**.
2. Click **Next**.
3. Click **Create factory software recovery CDs or DVDs to recover the system (Highly recommended)**, and then click **Next**.

The “Recovery Media Creator” page opens.

4. Click **Next**.

5. Click **Write to CD/DVD**, and then click **Next**.
6. Follow the on-screen instructions.

Performing a recovery

Performing a recovery from the recovery discs

Follow these steps to perform a recovery from the recovery discs:

1. Back up all personal files.
2. Insert the first recovery disc into the optical drive and restart the computer.
3. Follow the on-screen instructions.

Performing a recovery from the hard drive

There are two ways to initiate a recovery from the hard drive:

- From within Windows.
- From the recovery partition.

Initiating a recovery in Windows

To initiate a recovery in Windows, follow these steps:

1. Back up all personal files.
2. Select **Start > All Programs > HP Backup & Recovery > HP Backup and Recovery Manager**.
3. Click **Next**.
4. Click **Recover important files or the entire system**, and then click **Next**.
5. Click a recovery option, and then click **Next**.



NOTE If you choose to recover the system, the computer restarts and recovery begins.

6. Follow the on-screen instructions.

Initiating a recovery from the hard drive recovery partition

To initiate a recovery from the hard drive recovery partition, follow these steps:

1. Back up all personal files.
2. Restart the computer, and then press **f11** before the Windows operating system loads.
3. Click a recovery option, and then click **Next**.
4. Follow the on-screen instructions.

10 Connector pin assignments

Audio-out (headphone)

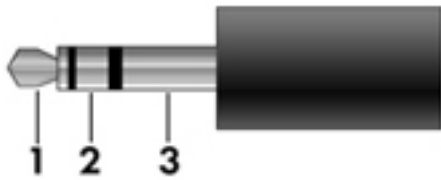

Pin	Signal
1	Audio out, left channel
2	Audio out, right channel
3	Ground

Audio-in (microphone)

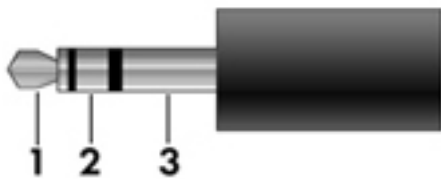

Pin	Signal
1	Audio signal in
2	Audio signal in
3	Ground

External monitor

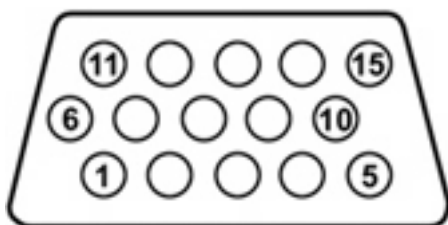

Pin	Signal
1	Red analog
2	Green analog
3	Blue analog
4	Not connected
5	Ground
6	Ground analog
7	Ground analog
8	Ground analog
9	+5 VDC
10	Ground
11	Monitor detect
12	DDC 2B data
13	Horizontal sync
14	Vertical sync
15	DDC 2B clock

RJ-11 (modem)

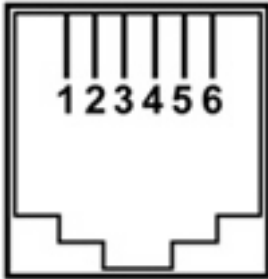

Pin	Signal
1	Unused
2	Tip
3	Ring
4	Unused
5	Unused
6	Unused

RJ-45 (network)

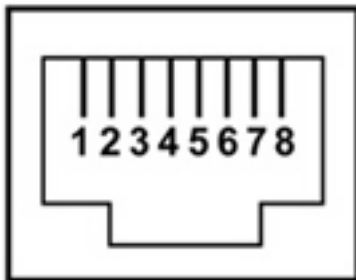

Pin	Signal
1	Transmit +
2	Transmit -
3	Receive +
4	Unused
5	Unused
6	Receive -
7	Unused
8	Unused

Universal Serial Bus

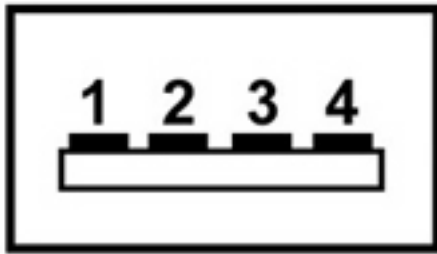

Pin	Signal
1	+5 VDC
2	Data -
3	Data +
4	Ground

11 Power cord set requirements

The wide range input feature of the computer permits it to operate from any line voltage from 100 to 120 volts AC or from 220 to 240 volts AC.

The 3-conductor power cord set included with the computer meets the requirements for use in the country or region where the equipment is purchased.

Power cord sets for use in other countries or regions must meet the requirements of the country or region where the computer is used.

Requirements for all countries or regions

The requirements listed below are applicable to all countries or regions:

- The length of the power cord set must be at least 1.5 m (5.0 ft) and no more than 2.0 m (6.5 ft).
- All power cord sets must be approved by an acceptable accredited agency responsible for evaluation in the country or region where the power cord set will be used.
- The power cord sets must have a minimum current capacity of 10 amps and a nominal voltage rating of 125 or 250 V AC, as required by each country or region's power system.
- The appliance coupler must meet the mechanical configuration of an EN 60 320/IEC 320 Standard Sheet C13 connector for mating with the appliance inlet on the back of the computer.

Requirements for specific countries or regions

Region	Accredited agency	Applicable note number
Australia	EANSW	1
Austria	OVE	1
Belgium	CEBC	1
Canada	CSA	2
Denmark	DEMKO	1
Finland	FIMKO	1
France	UTE	1
Germany	VDE	1
Italy	IMQ	1
Japan	METI	3
Korea	EK	4
The Netherlands	KEMA	1
Norway	NEMKO	1
The People's Republic of China	CCC	5
Sweden	SEMKO	1
Switzerland	SEV	1
Taiwan	BSMI	4
The United Kingdom	BSI	1
The United States	UL	2

1. The flexible cord must be Type HO5VV-F, 3-conductor, 1.0-mm² conductor size. Power cord set fittings (appliance coupler and wall plug) must bear the certification mark of the agency responsible for evaluation in the country or region where it will be used.
2. The flexible cord must be Type SPT-3 or equivalent, No. 18 AWG, 3-conductor. The wall plug must be a two-pole grounding type with a NEMA 5-15P (15 A, 125 V) or NEMA 6-15P (15 A, 250 V) configuration.
3. The appliance coupler, flexible cord, and wall plug must bear a "T" mark and registration number in accordance with the Japanese Dentori Law. The flexible cord must be Type VCT or VCTF, 3-conductor, 1.00-mm² conductor size. The wall plug must be a two-pole grounding type with a Japanese Industrial Standard C8303 (7 A, 125 V) configuration.
4. The flexible cord must be Type RVV, 3-conductor, 0.75-mm² conductor size. Power cord set fittings (appliance coupler and wall plug) must bear the certification mark of the agency responsible for evaluation in the country or region where it will be used.
5. The flexible cord must be Type VCTF, 3-conductor, 0.75-mm² conductor size. Power cord set fittings (appliance coupler and wall plug) must bear the certification mark of the agency responsible for evaluation in the country or region where it will be used.

12 Recycling

Battery

When a battery has reached the end of its useful life, do not dispose of the battery in general household waste. Follow the local laws and regulations in your area for computer battery disposal.

Display



WARNING! The backlight contains mercury. Exercise caution when removing and handling the backlight to avoid damaging this component and causing exposure to the mercury.



CAUTION The procedures in this appendix can result in damage to display components. The only components intended for recycling purposes are the liquid crystal display (LCD) panel and the backlight. Careful handling should be exercised when removing these components. When you remove these components, handle them carefully.



NOTE Materials Disposal. This HP product contains mercury in the backlight in the display assembly that might require special handling at end-of-life. Disposal of mercury may be regulated because of environmental considerations. For disposal or recycling information, contact your local authorities, or see the Electronic Industries Alliance (EIA) Web site at <http://www.eiae.org>.

This section provides disassembly instructions for the display assembly. The display assembly must be disassembled to gain access to the backlight (1) and the liquid crystal display (LCD) panel (2).



NOTE The procedures provided in this appendix are general disassembly instructions. Specific details, such as screw sizes, quantities, and locations, and component shapes and sizes, can vary from one computer model to another.

Perform the following steps to disassemble the display assembly:

1. Remove all screw covers (1) and screws (2) that secure the display bezel to the display assembly.

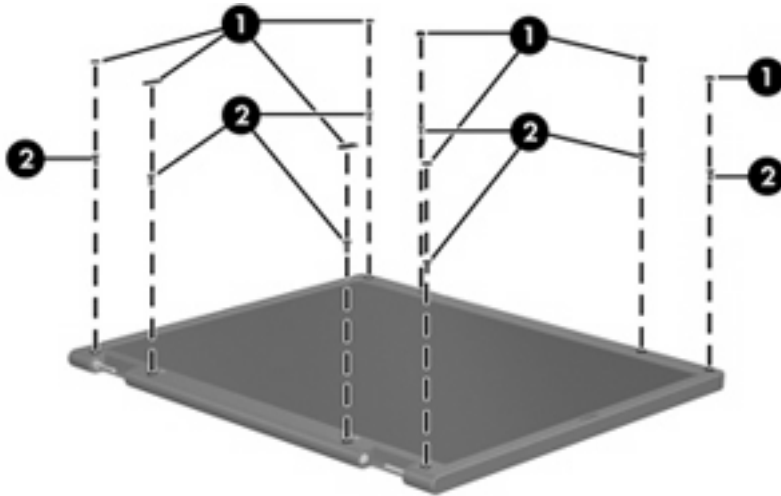

2. Lift up and out on the left and right inside edges (1) and the top and bottom inside edges (2) of the display bezel until the bezel disengages from the display assembly.
3. Remove the display bezel (3).

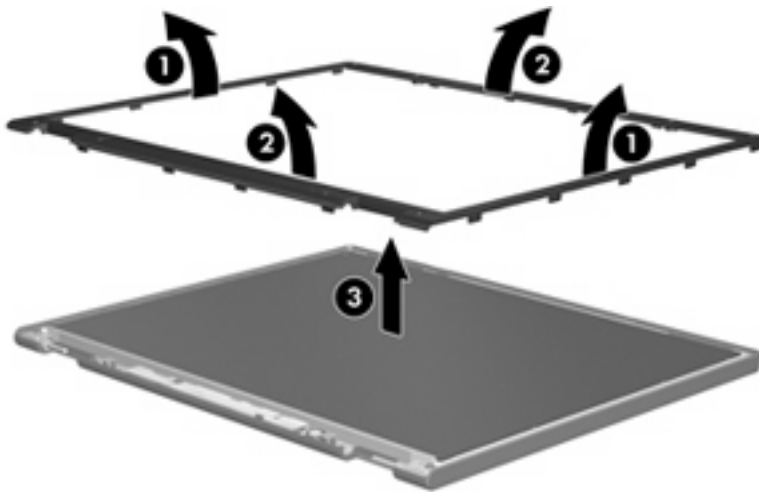

4. Disconnect all display panel cables (1) from the display inverter and remove the inverter (2).

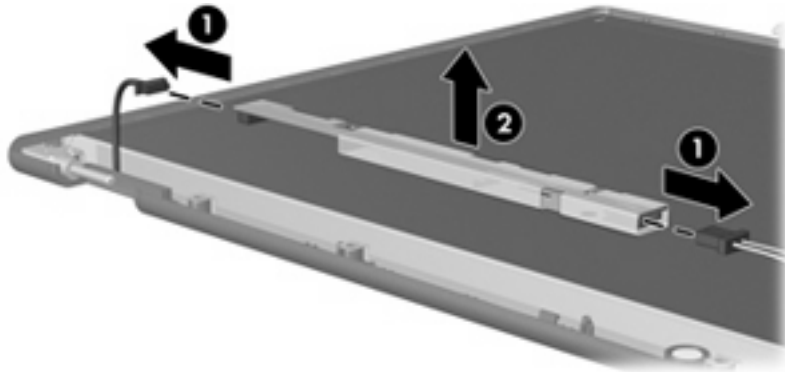

5. Remove all screws (1) that secure the display panel assembly to the display enclosure.
6. Remove the display panel assembly (2) from the display enclosure.

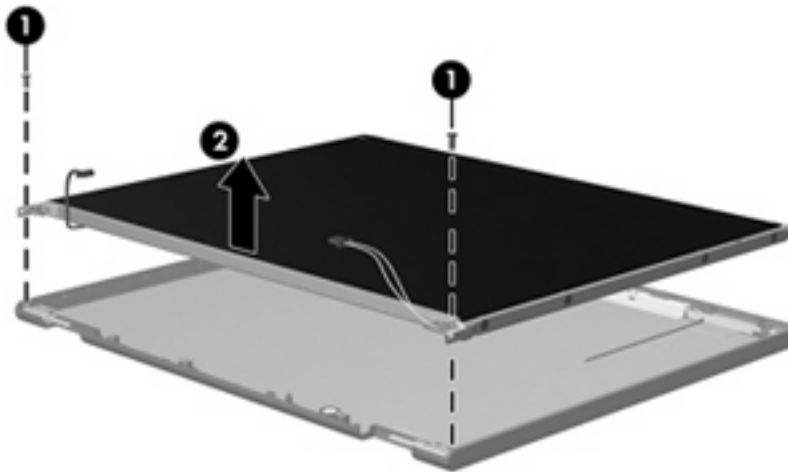

7. Turn the display panel assembly upside down.
8. Remove all screws that secure the display panel frame to the display panel.

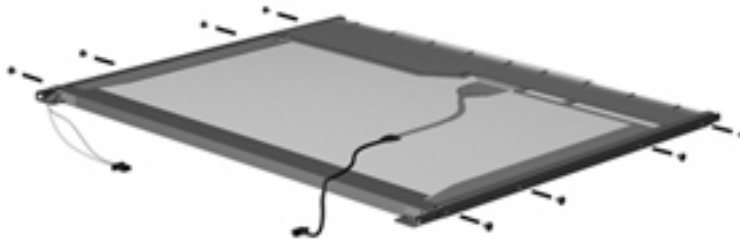

9. Use a sharp-edged tool to cut the tape (1) that secures the sides of the display panel to the display panel frame.

10. Remove the display panel frame (2) from the display panel.

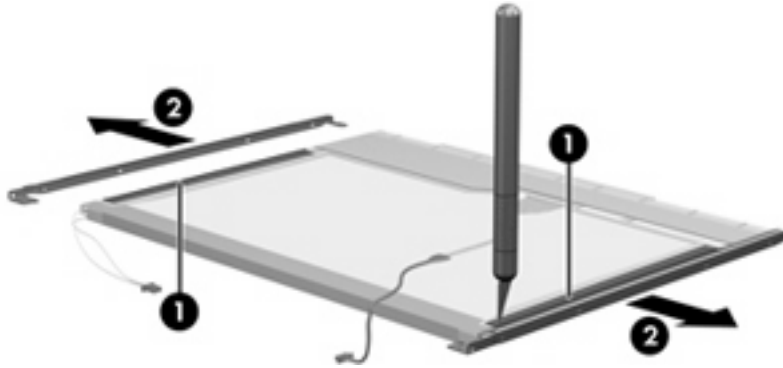

11. Remove the screws (1) that secure the backlight cover to the display panel.
12. Lift the top edge of the backlight cover (2) and swing it outward.

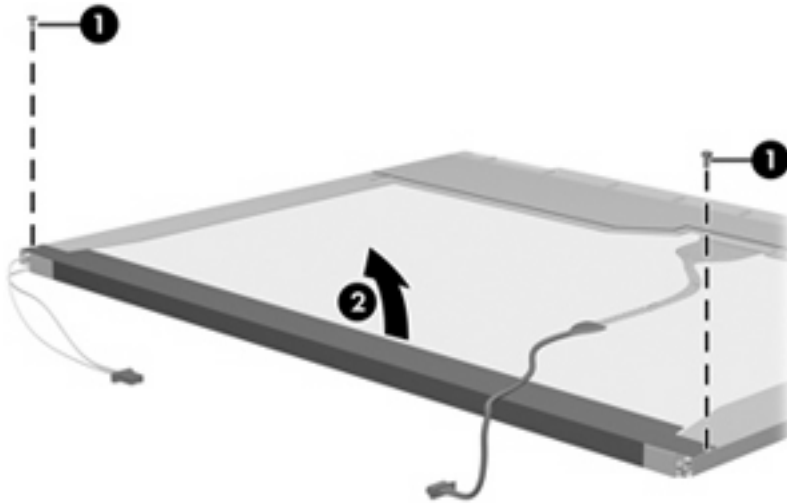

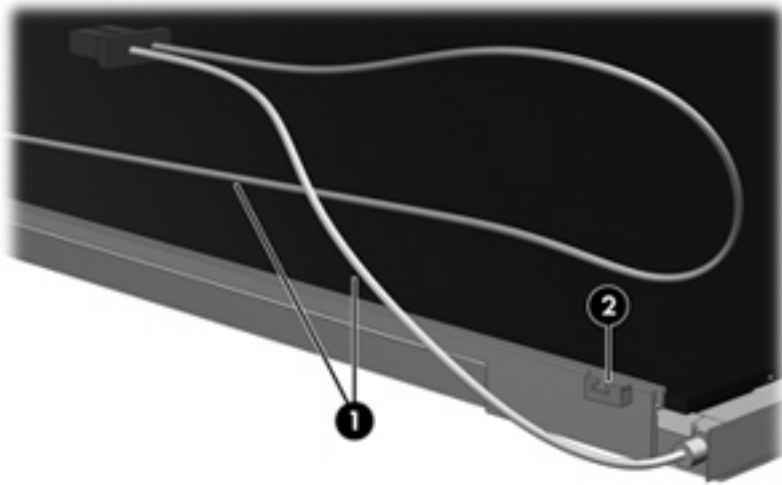

13. Remove the backlight cover.
14. Turn the display panel right-side up.

15. Remove the backlight cables (1) from the clip (2) in the display panel.

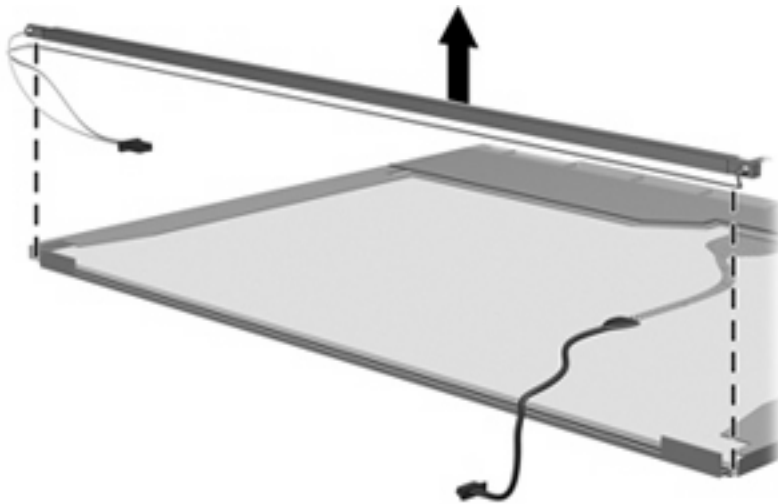

16. Turn the display panel upside down.
17. Remove the backlight frame from the display panel.



 **WARNING!** The backlight contains mercury. Exercise caution when removing and handling the backlight to avoid damaging this component and causing exposure to the mercury.

18. Remove the backlight from the backlight frame.

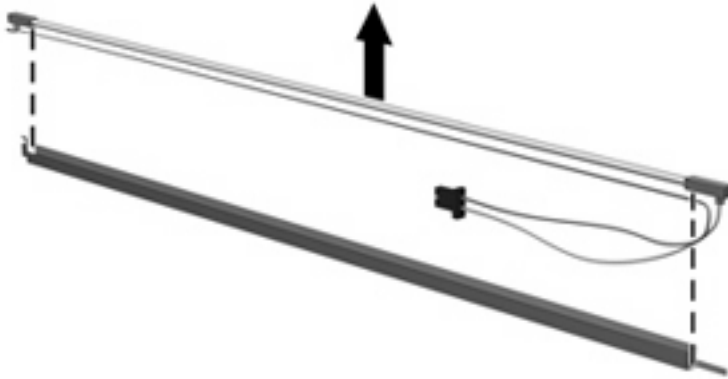

19. Disconnect the display cable (1) from the LCD panel.
20. Remove the screws (2) that secure the LCD panel to the display rear panel.
21. Release the LCD panel (3) from the display rear panel.
22. Release the tape (4) that secures the LCD panel to the display rear panel.

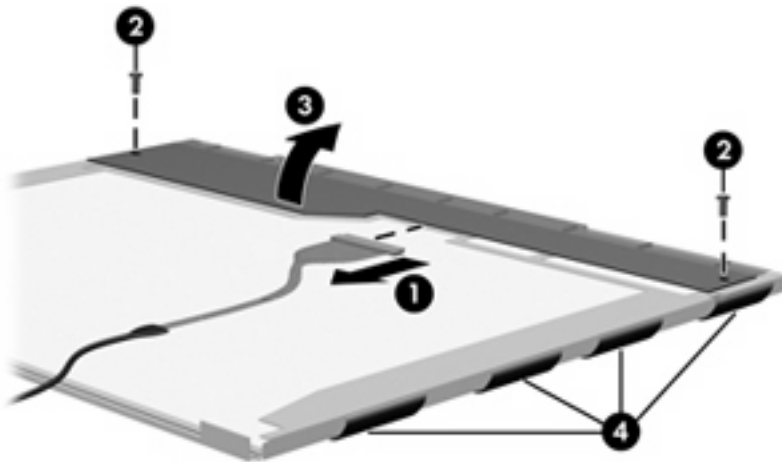

23. Remove the LCD panel.

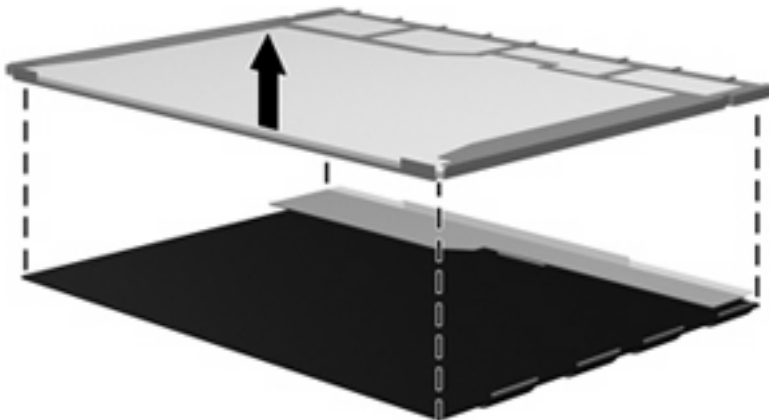

24. Recycle the LCD panel and backlight.

Index

A

AC adapter, spare part
number 19, 20
antennae
 disconnecting 35
 illustrated 16
 location 7
 spare part number 16
applications key, Windows 5
audio, product description 2
audio-in jack
 location 7
 pin assignments 100
audio-out jack
 location 7
 pin assignments 100

B

backup 95
base enclosure
 removal 49
 spare part number 15, 22,
 49
battery
 removal 29
 spare part number 15, 21,
 29
 specifications 73
battery bay 10
battery light 7
battery release latch 10
bezel
 illustrated 16
 removal 46
 spare part number 16, 21,
 46
boot options 68
boot order 68
bottom components 10

button board
 removal 43
 spare part number 14, 22,
 43

C

cables, service considerations 23
caps lock light 6
chipset, product description 1
CMOS clearing 11
components
 bottom 10
 front 4, 7
 keyboard 5
 left-side 9
 right-side 8
 top 6
computer feet
 locations 32
 spare part number 15, 21,
 32
Computer Setup
 accessing 65
 Diagnostics menu 68
 file menu 67
 overview 65
 restoring defaults 66
 Security menu 67
 System Configuration
 menu 68
computer specifications 70
connector pin assignments
 audio-in 100
 audio-out 100
 external monitor 101
 headphone 100
 microphone 100
 modem 102
 monitor 101
 network 102

RJ-11 102
RJ-45 102
Universal Serial Bus
 (USB) 103
connectors, service
 considerations 23

D

Diagnostics menu 68
diskette drive
 precautions 24
 product description 2
display assembly
 removal 44
 spare part numbers 13, 22,
 44
display bezel
 illustrated 16
 removal 46
 spare part number 16, 21,
 46
Display Bezel Kit, spare part
 number 21
Display Bracket Kit, spare part
 number 16
Display Cable Kit, spare part
 number 16, 21
display component recycling 107
display enclosure
 illustrated 16
 spare part numbers 16, 21
display hinge
 illustrated 16
 spare part number 16, 21,
 48
Display Hinge Kit, spare part
 number 16, 21, 48
display inverter
 illustrated 16

- removal 47
- spare part number 16, 22, 47
- Display Label Kit, spare part number 21
- display panel
 - illustrated 16
 - removal 47
 - spare part number 16, 21, 47
- Display Screw Cover Kit, spare part number 16
- Display Screw Kit, spare part number 16, 22
- display specifications 71
- display switch 6
- docking support, product description 2
- drives, boot order 68
- drives, preventing damage 24
- DVD±RW and CD-RW Super Multi Double-Layer Combo Drive
 - precautions 24
 - removal 36
 - spare part number 15, 18, 20, 36
 - specifications 74
- DVD±RW/R and CD-RW Double-Layer Combo Drive
 - precautions 24
 - removal 36
 - spare part number 15, 18, 20, 36
 - specifications 75

E

- electrostatic discharge 24
- Ethernet, product description 2
- Execution Disable 69
- external media cards, product description 2
- external monitor port
 - location 9
 - pin assignments 101

F

- fan assembly
 - removal 52
 - spare part number 15, 20, 52

feet

- locations 32
- spare part number 15, 21, 32
- File menu 67
- front components 4, 7
- function keys 5

G

- graphics, product description 1
- grounding equipment and methods 27

H

- hard drive
 - precautions 24
 - product description 1
 - removal 30
 - spare part numbers 16, 18, 20, 30
 - specifications 72
- hard drive bay 10
- hard drive bracket, removal 31
- hard drive cover
 - illustrated 17
 - removal 30
- hard drive test 68
- headphone jack
 - location 7
 - pin assignments 100
- heat sink
 - removal 53
 - spare part number 15, 20, 53

hinge

- illustrated 16
- removal 48
- spare part number 16, 21, 48

I

- I/O address specifications 78
- Intel SpeedStep 69
- interrupt specifications 77
- inverter
 - illustrated 16
 - removal 47
 - spare part number 16, 22, 47

K

- keyboard
 - product description 2
 - removal 40
 - spare part numbers 14, 20, 40
- keyboard components 5
- keypad keys 5
- keys
 - esc 5
 - fn 5
 - function 5
 - Windows applications 5
 - Windows logo 5

L

- label, spare part number 21
- LAN Power Save 69
- language, changing in Computer Setup 68
- left-side components 9

M

- mass storage devices, spare part numbers 18
- memory check 68
- memory map specifications 80
- memory module
 - product description 1
 - removal 32
 - spare part numbers 15, 21, 32
- memory module compartment 10
- memory/Mini PCI card module cover
 - illustrated 17
 - removal 33
- microphone jack
 - location 7
 - pin assignments 100
- Mini PCI card module
 - removal 34
 - spare part numbers 15, 20, 34
- model name 1
- modem jack
 - location 9
 - pin assignments 102
- modem module, product description 2

monitor port
location 9
pin assignments 101

N

network jack
location 9
pin assignments 102

O

operating system, product
description 3
optical drive
location 8
precautions 24
product description 2
removal 36
spare part numbers 15, 18,
36
specifications 74, 75
optical drive bracket, removal 37
optical drive connector board
removal 60
spare part number 15, 22,
60

P

packing guidelines 26
panels, product description 1
parallel port mode 69
password clearing 11
passwords 67
PC Card assembly
removal 61
spare part number 15, 21,
61
PC Card eject button 9
PC Card slot 9
PC Card slot bezel
illustrated 17
spare part number 15, 20,
61
plastic parts 23
Plastics/Hardware Kit
contents 17
spare part number 15, 17,
22
pointing devices
configuring 68
product description 2
ports, product description 2

power button 6
power connector 9
power cord
set requirements 104
spare part numbers 19, 20
power light 6
power requirements, product
description 3
processor
product description 1
removal 55
spare part numbers 15, 21,
22, 55
product description
audio 2
chipset 1
diskette drive 2
docking support 2
Ethernet 2
external media cards 2
graphics 1
hard drives 1
keyboard 2
memory module 1
modem module 2
operating system 3
optical drives 2
panels 1
pointing devices 2
ports 2
power requirements 3
processors 1
product name 1
security 3
serviceability 3
wireless 2
product name 1

R

recovery 97
recovery discs, creating 98
removal/replacement
preliminaries 23
procedures 28
restore defaults 66
right-side components 8
RJ-11 jack
location 9
pin assignments 102

RJ-45 jack
location 9
pin assignments 102
RTC battery
removal 51
spare part number 15, 21,
51
Rubber Feet Kit, spare part
number 15, 21, 32

S

Screw Kit
contents 81
spare part number 19, 22
screw listing 81
security cable slot 8
Security menu 67
security, product description 3
serial number 12, 28
service considerations 23
serviceability, product
description 3
setup utility
accessing 65
Diagnostics menu 68
File menu 67
restoring defaults 66
Security menu 67
System Configuration
menu 68
speaker
location 6
removal 56
spare part number 15, 22,
56
specifications
battery 73
computer 70
display 71
DVD±RW and CD-RW Super
Multi Double-Layer Combo
Drive 74
DVD±RW/R and CD-RW
Double-Layer Combo
Drive 75
hard drive 72
I/O addresses 78
interrupts 77
memory map 80

- optical drive 74, 75
- system DMA 76
- SpeedStep Technology 69
- static-shielding materials 27
- switch cover
 - removal 38
 - spare part numbers 14, 22, 38
- system board
 - removal 58
 - spare part numbers 15, 22, 58
- System Configuration menu 68
- system DMA 76
- system fan 69
- system information 67
- system memory map 80

T

- thermal paste, replacement 54
- tools required 23
- top components 6
- top cover, spare part number 14, 22
- TouchPad 4
- TouchPad cable
 - removal 63
 - spare part number 14, 22, 63
- TouchPad left button 4
- TouchPad right button 4
- TouchPad scroll zone 4
- transporting guidelines 26

U

- Universal Serial Bus (USB) port
 - location 9
 - pin assignments 103
- unknown password 11
- USB legacy support 68

V

- vents 9, 10

W

- Windows applications key 5
- Windows logo key 5
- wireless antennae
 - disconnecting 35
 - illustrated 16
 - location 7

- removal 48
- spare part number 16, 22, 48
- wireless button 6
- wireless light 6
- wireless, product description 2
- workstation guidelines 26

